

TargetDoser

Instruction Manual

Original Instructions



CE

Doc. no.: 15757028-01_A_en
Date of release: 2021.02.12

Copyright

The contents of this manual are the property of Struers ApS. Reproduction of any part of this manual without the written permission of Struers ApS is not allowed.

All rights reserved. © Struers ApS 2021.02.12.

Table of Contents

1 About this manual	5
2 Safety	5
2.1 Intended use - TargetDoser	5
2.1.1 TargetDoser safety precautions	5
2.2 Safety messages	6
2.3 Safety messages in this manual	7
3 Getting started	7
3.1 Device description	7
3.2 TargetDoser- Front view	8
3.3 TargetDoser- Rear view	8
3.4 Accessories and consumables	8
4 Transport and storage	9
4.1 Transport	9
4.2 Long-term storage or shipping	9
5 Installation	10
5.1 Unpacking	10
5.2 Checking the packing list	10
5.3 Lifting	10
5.4 Location	10
5.5 Installation - TargetDoser	11
5.6 Connecting TargetDoser	11
5.7 Pump connections	11
5.8 Water supply for OP flushing	12
5.9 Noise	12
6 Preparing the device	12
6.1 Control panel functions - TargetDoser	12
6.2 Configuring TargetDoser	13
6.3 Bottle configuration	14
6.4 Configuring a user surface	15
6.5 Configuring a user suspension	15
6.6 Configuring a user lubricant	16
6.7 Configuring operation mode	17
6.8 New pass code	17

7	Operating the device	18
7.1	The preparation process	18
7.2	Target mode	19
7.3	Preparation methods	19
7.3.1	Plane grinding before starting preparation	19
7.3.2	Methods - general recommendations	20
7.3.3	User methods	20
7.4	Optimizing a user method	31
7.5	Working with methods in TargetDoser	31
7.5.1	Preparation modes	32
7.5.2	Time mode	32
7.5.3	Removal mode	32
7.5.4	Target mode	33
7.5.5	Struers Methods	34
7.5.6	Method groups	34
7.5.7	Creating method groups	35
7.5.8	Deleting a method group	36
7.6	Transmitting a method to TargetMaster	36
8	Maintenance and service - TargetDoser	36
8.1	General cleaning	37
8.2	Daily	37
8.3	Weekly	37
8.4	Tube cleaning	37
8.5	Annually	37
8.5.1	Changing tubes	37
8.6	Spare parts	38
8.7	Disposal	39
9	Technical data	39
9.1	Technical data - TargetDoser	39
9.2	Noise and vibration levels	40
9.3	Diagrams	40
9.3.1	Diagrams - TargetDoser	40
9.4	Legal and regulatory information	43
10	Manufacturer	43
	Declaration of Conformity	44

1 About this manual

Instruction Manuals

Struers equipment must only be used in connection with and as described in the instruction manual supplied with the equipment.



Note

Read the instruction manual carefully before use.



Note

If you wish to view specific information in detail, see the online version of this manual.

2 Safety

2.1 Intended use - TargetDoser

Dosing system (05756904)

TargetDoser is a support system for programming and control of preparation methods and dosing of polishing suspensions and lubricants to TargetMaster. TargetDoser is prepared with space for liquid bottles, and it comes complete with pumps.

The equipment is designed to be used only with Struers consumables specifically designed for this purpose and this type of machine.

The machine must be operated only by skilled/trained personnel.

The machine is for use in a professional working environment (e.g. a materialographic laboratory).

Do not use the machine for the following The machine may not be used with consumables and accessories which are not compatible with the equipment.

Model TargetDoser

2.1.1 TargetDoser safety precautions



Read carefully before use

1. Ignoring this information and mishandling of the equipment can lead to severe bodily injuries and material damage.
2. The operator must read the safety precautions and Instruction Manual, as well as relevant sections of the manuals for any connected equipment and accessories. The operator must

- read the Instruction Manual and, where applicable, the Safety Data Sheets for the applied consumables.
3. The machine must be placed on a safe and stable table with an adequate working height. The machine must be installed in compliance with local safety regulations. All functions on the machine and any connected equipment must be in working order.
 4. Alcohol-based consumables: follow the current safety rules for handling, mixing, filling, emptying and disposing of alcohol-based liquids.
 5. If you observe malfunctions or hear unusual noises, stop the machine and call technical service.
 6. In case of fire, alert bystanders and the fire brigade. Disconnect the electrical power supply. Use a powder fire extinguisher. Do not use water.
 7. Struers equipment must only be used in connection with and as described in the instruction manual supplied with the equipment.
 8. If the equipment is subjected to misuse, incorrect installation, alteration, neglect, accident or incorrect repair, Struers will accept no responsibility for damage to the user or the equipment.
 9. Dismantling of any part of the equipment, during service or repair, should always be performed by a qualified technician (electromechanical, electronic, mechanical, pneumatic, etc.).

2.2 Safety messages

Signs used in safety messages

Struers uses the following signs to indicate potential hazards.



ELECTRICAL HAZARD

This sign indicates an electrical hazard which, if not avoided, will result in death or serious injury.



DANGER

This sign indicates a hazard with a high level of risk which, if not avoided, will result in death or serious injury.



WARNING

This sign indicates a hazard with a medium level of risk which, if not avoided, could result in death or serious injury.



CAUTION

This sign indicates a hazard with a low level of risk which, if not avoided, could result in minor or moderate injury.



CRUSHING HAZARD

This sign indicates a crushing hazard which, if not avoided, could result in minor, moderate or serious injury.

General messages**Note**

This sign indicates that there is a risk of damage to property, or a need to proceed with special care.

**Hint**

This sign indicates that additional information and hints are available.

2.3 Safety messages in this manual**CAUTION**

Struers equipment must only be used in connection with and as described in the instruction manual supplied with the equipment.

**ELECTRICAL HAZARD**

The machine must be earthed (grounded).
Make sure that the actual electrical power supply voltage corresponds to the voltage stated on the type plate of the machine.
Incorrect voltage can damage the electrical circuit.

**CAUTION**

Do not use the machine with non-compatible accessories or consumables.

**CRUSHING HAZARD**

Take care of your fingers when handling the machine.
Wear safety shoes when handling heavy machinery.

3 Getting started**3.1 Device description**

TargetDoser is designed as a support system for TargetMaster. TargetDoser is used for programming of preparation methods for the TargetMaster. TargetDoser also supplies TargetMaster with polishing suspensions, polishing lubricants and cleaning medias.

The operator program the methods on the TargetDoser user interface and then transfer it to theTargetMaster. The polishing medias are automatically dosed based on the parameters given in the method used.

Additional suspension and lubricant can be dosed manually by using the buttons on the TargetMaster.

Note
 NOTE: The machine is developed to be used only with suitable consumables and accessories (e.g. polishing discs) designed for this purpose and this type of machine. The equipment is designed to be used only with Struers consumables specifically designed for this purpose and this type of machine.

3.2 TargetDoser- Front view

- A Display
- B Function keys
- C Scroll up/Scroll down
- D Esc
- E Enter

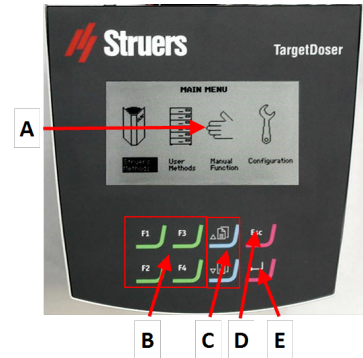

3.3 TargetDoser- Rear view

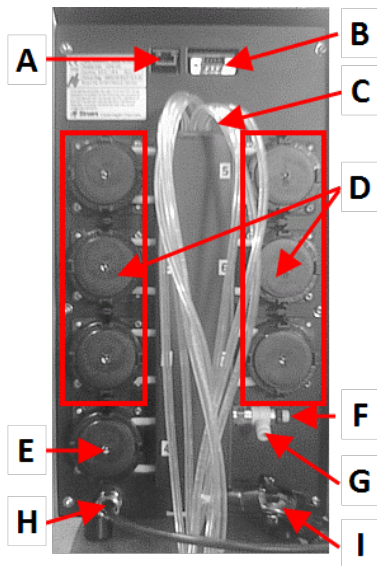

- A Network connection (RJ45)
- B Service connector (serial port connector)
- C Supply tubes from lubricant/suspension bottles
- D Pumps (1-6)
- E OP-suspension pump
- F Regulation valve for water pressure
- G Water connection from TargetMaster for OP-pump
- H Power and interface connection from TargetMaster
- I Tubes for TargetMaster multi-dosing head

3.4 Accessories and consumables

Accessories

For information about the available range, see the brochure for TargetDoser:

- [The Struers Website](http://www.struers.com) (http://www.struers.com)

Consumables

The equipment is designed to be used only with Struers consumables specifically designed for this purpose and this type of machine.

Other products may contain aggressive solvents, which dissolve e.g. rubber seals. The warranty may not cover damaged machine parts (e.g. seals and tubes), where the damage can be directly related to the use of consumables not supplied by Struers.

For information about the available range, see:

- [The Struers Consumables Catalogue](http://www.struers.com/Library) (<http://www.struers.com/Library>)

4 Transport and storage

If, at any time after the installation, you have to move the unit or place it in storage, there is a number of guidelines we recommend that you follow.

- Package the unit securely before transportation.
Insufficient packaging could cause damage to the unit and will void the warranty. Contact Struers Service.
- Struers recommends that all original packaging and fittings are kept for future use.

4.1 Transport

- Disconnect the unit from the electrical power supply.
- Lift the machine onto a stable surface.

4.2 Long-term storage or shipping

**Note**

Struers recommends that all original packaging and fittings are kept for future use.

- Remove any other accessories.
- Clean and dry the unit before storage.
- Disconnect the unit from the electrical power supply.
- Place the machine and accessories in their original packaging.

5 Installation



WARNING

Struers equipment must only be used in connection with and as described in the instruction manual supplied with the equipment.

5.1 Unpacking



Note

Struers recommends that all original packaging and fittings are kept for future use.

1. Cut the packing tape on the top of the box.
2. Remove the loose parts.
3. Remove the unit from the box.

5.2 Checking the packing list

1. Unpack TargetDoser.

The packing box contains the following items:

Pcs.	Description
1	TargetDoser
1	Dosing bottle box with built-in pumps, 3 large bottles and 4 small bottles
1	Bottle of soap solution (1 l)

5.3 Lifting



CRUSHING HAZARD

Take care of your fingers when handling the machine.
Wear safety shoes when handling heavy machinery.

Weight	
TargetDoser	15 kg (33 lbs)

5.4 Location

Operating environment

System accuracy is dependent on an environment with a stable temperature.

- Ambient conditions
See [Technical data - TargetDoser ▶ 39](#), Operating environment.

Location**CRUSHING HAZARD**

Take care of your fingers when handling the machine.
Wear safety shoes when handling heavy machinery.

- To facilitate easy access for service technicians, allow sufficient space around the machine.
- Place the machine on a rigid, stable workbench with a horizontal surface and an adequate height.
- Make sure that there is enough space, to position TargetDoser to the left of TargetMaster.

5.5 Installation - TargetDoser

1. Place TargetDoser as close as possible to the left of TargetMaster.

**Note**

The tubes connecting TargetDoser to TargetMaster are pre-mounted on TargetDoser.

2. Make sure that TargetDoser does not interfere with the operating functions of TargetMaster.

5.6 Connecting TargetDoser

The electrical connection from TargetMaster supplies the TargetDoser with a 24 V power supply to TargetDoser and a data bus, which enables the two machines to communicate.

**CAUTION**

Switch off the electrical power supply before installing electrical equipment.

1. Switch off TargetMaster.
2. Connect the cable from the rear of TargetDoser to the TargetDoser connector on the rear of TargetMaster.

For more information on how to connect TargetDoser to TargetMaster, see the Instruction Manual for TargetMaster.

5.7 Pump connections

TargetDoser is supplied fitted with 7 pumps:

Pump 1, 2, 3 and 4	Diamond suspension/Lubricant
Pump 5	Alcohol
Pump 6	Soap
Pump 7	OP suspension

**Note**

The allocation of the pumps is very specific and must not be changed.

The dimensions of pumps 5, 6 and 7 are different from the other pumps, as they are designed for specific purposes.

Note
The distance between TargetDoser and TargetMaster is determined by the length of the tubes. Do not increase the length of the tubes, as this has already been optimized from the factory.

Connecting the tubes

Each tube is numbered according to the pump to which it is to be connected.

1. Connect the tubes from each pump to the corresponding connector on the side of TargetMaster.
2. Do so until all tubes are connected.



5.8 Water supply for OP flushing

1. Connect the water tube supplied to the quick coupling on the rear of the TargetMaster.
2. Connect the other end of the water tube to the quick coupling on the rear of the TargetDoser.

Note
Do not push the water tube all the way into the quick coupling as this can squeeze the tube and result in reduced water flow.

5.9 Noise





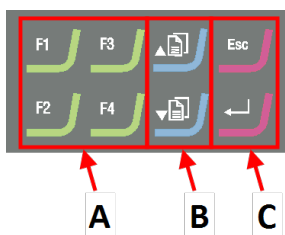

For information on the sound pressure level value, see this section: [Noise and vibration levels](#) ► 40

6 Preparing the device

6.1 Control panel functions - TargetDoser



- A Function keys - F1 to F4
- B Scroll up/Scroll down
- C Escape, Enter

Button	Function
 to 	Function key <ul style="list-style-type: none"> Press this button to activate controls for various purposes. See the bottom line of the individual screens.
	Scroll up <ul style="list-style-type: none"> Press this button to scroll up in a screen and to increase the value of a setting.
	Scroll down <ul style="list-style-type: none"> Press this button to scroll down in a screen and to decrease the value of a setting.
	Escape <p>Use this button on the control panel to return to previous functions or values.</p> <ul style="list-style-type: none"> Press the button to return to the main menu. Press the button to return to the last function or value. Press the button to cancel changes.
	Select/Enter <ul style="list-style-type: none"> Press this button to enter a field, for instance a setting, to select a value, and to confirm a selection.

6.2 Configuring TargetDoser

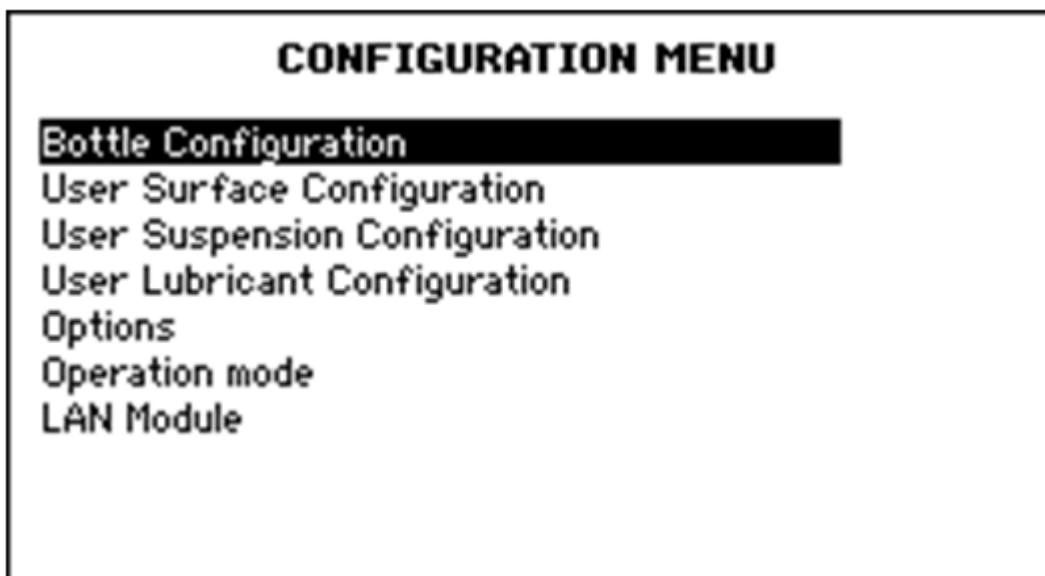

You must configure the following settings before you start using the machine:

- See [Bottle configuration](#) ► 14

To define other settings, see:

- [Configuring a user surface ▶ 15](#)
- [Configuring a user suspension ▶ 15](#)
- [Configuring a user lubricant ▶ 16](#)
- [Configuring operation mode ▶ 17](#)
- [The menu ▶ 1](#)

6.3 Bottle configuration

Note
You must configure this setting before you start using the machine.

Use this option to define which suspensions or lubricants you are using in the bottles connected to the pumps.

Struers recommends that you use DiaPro consumables.

1. From the **Main menu** screen, select the **Configuration** screen.
2. From the **Configuration** screen, select the **Bottle configuration** screen.
3. Select the **Lub./Susp.** column.

Note
Bottle 7 can only be configured for OP or AP suspension.

4. Press **Enter** to toggle between lubricant and suspension.
5. Select the **Type** column.
6. Activate the **SELECT LUBRICANT TYPE** or **SELECT SUSPENSION TYPE** list.
7. Highlight the desired suspension or lubricant.
8. Press **Enter** to select.
9. Repeat the above steps for all bottles.
10. Set the status of the bottles as **Filled**.
11. Confirm your selections and return to the **Configuration** screen.



Refilling soap and alcohol bottles

1. Set the status of the bottles as **Filled**.



Note

You must fill both the soap and the alcohol bottles before you can set their status as **Filled**.

If you do not set the status as **Filled**, the system may show a warning message stating that one of the bottles may run dry during the preparation.

6.4 Configuring a user surface

You can define up to 10 new user-defined surfaces. You can define the name, the abrasive rule and the lubricant rule for each surface.

Procedure

1. From the **Main menu** screen, select the **Configuration** screen.
2. From the **Configuration** screen, select the **User surface configuration** screen.
3. Select the **Surface name** column.
4. Select the row indicating the surface you wish to configure.
5. Open the text editor.
6. Enter the name of the new surface.
7. Select the **Abr. rule** column.
8. Select the **SELECT ABRASIVE RULE** screen.
9. Select the desired abrasive rule.
10. Press **Enter** to select.
11. Return to the **Configuration** screen.



Note

Make sure that you select the correct rules for each surface, as this will affect the suspensions and lubricants that are available when you create a new preparation method.

6.5 Configuring a user suspension

You can define up to 10 new user-defined suspensions. You can define the name, the abrasion type and the lubricant rule for each suspension

1. From the **Main menu** screen, select the **Configuration** screen.
2. From the **Configuration** screen, select the **User suspension configuration** screen.
3. Select **Susp. name** column.
4. Select the row indicating the suspension you wish to configure.
5. Open the text editor.
6. Enter the name of the new suspension.
7. Select the **Abr. type** column.
8. Select the **SELECT ABRASIVE TYPE** screen.
9. Select the desired abrasive type.
10. Select the **Lub. rule** column.
11. Select the **SELECT LUBRICANT RULE** screen.
 - If the suspension used requires the use of a lubricant, select **Other lub. except water**.
 - If the suspension does not require a lubricant, select **No lubricant**.
 - If the abrasive is only to be used with water-free lubricants, select **Only waterfree lubricants**.
12. Press **Enter** to select.
13. Return to the **Configuration** screen.



6.6 Configuring a user lubricant

You can define up to 10 new user-defined lubricants. You can define the name and the lubricant type.

1. From the **Main menu** screen, select the **Configuration** screen.
2. From the **Configuration** screen, select the **User lubricant configuration** screen.
3. Select the **Lubricant name** column.
4. Select the row indicating the lubricant you wish to configure.
5. Press **Enter** to open the text editor.
6. Enter the name of the new lubricant.
7. Select the **Lubricant type** column.
8. Select the row indicating the lubricant you wish to configure.



9. Activate the **SELECT LUBRICANT TYPE** list.
 - If the lubricant contains water, select **Lubricant containing water**.
 - If the lubricant is waterfree, select **Waterfree lubricant**.
10. Press **Enter** to select.
11. Return to the **Configuration** screen.



6.7 Configuring operation mode

You can restrict access to the software in the **Operation mode** screen.

1. From the **Main menu** screen, select the **Configuration** screen.
2. From the **Configuration** screen, select the **Operation mode** screen.
3. Configure **Current operation mode**.
4. Enter the pass code.
The default pass code is **176**.
5. Confirm the pass code.
6. Select the operation mode. The options are:
 - **Process**
Methods can be selected and viewed, but not edited.
 - **Development**
Methods can be selected, viewed and edited
 - **Configuration**
Methods can be selected, viewed and edited.
Bottles can be configured and the IP address can be reset.
7. Confirm the setting.



6.8 New pass code

When you access the **Operation mode** screen, you will be prompted to enter a pass code.

Changing the pass code

You can change the pass code from the **Operation mode** screen.



Note

Make a note of the new pass code.
The default pass code is **176**.

To change the pass code, do the following:

1. From the **Main menu** screen, select the **Configuration** screen.
2. From the **Configuration** screen, select the **Operation mode** screen.
3. Access the **Pass code** field.
4. Enter the pass code.
5. Access the **Pass code** field.
6. Access the **New pass code** field.
7. Enter the new pass code.
8. Confirm the new pass code.



7 Operating the device

7.1 The preparation process

To operate TargetSystem correctly, follow the steps below in the order shown.

Before starting, make sure that all instruments in the system are switched on.

Temperature

1. Make sure that the ambient temperature is 20°C (68°F) $\pm 2^{\circ}\text{C}$ (4°F).
2. Make sure that the temperature has been within the limit stated above for at least one hour before you start operating TargetMaster.
3. Make sure that the temperature of the sample holder is within the limit stated above .
4. To minimize the effect of temperature fluctuations, carry out the preparation process without taking long breaks between the steps.

Preparation

1. Fasten the sample to the sample chair or sample holder.
2. Mount the sample chair or sample holder on TargetGrip and secure it with the Allen screwdriver supplied.

Selecting a method

1. Select the correct preparation method on TargetDoser and transmit it to TargetMaster.

7.2 Target mode

Use **Target mode** to determine the distance from the reference edge on TargetGrip to the target area you need to inspect.

Removal mode

Use **Removal mode** to determine the distance from the edge of the sample chair (the reference edge) to the target area you need to inspect.

7.3 Preparation methods

Preparation methods are stored in and loaded from TargetDoser.

See [Transmitting a method to TargetMaster ▶ 36](#)

In TargetMaster, removal is controlled by two separate measuring systems.

- Removal in grinding steps until 175 μm from the grinding/polishing transition
An electronic measuring system continuously measures the distance to the target. Consequently, the major part of the target distance is covered as quickly as possible.
- Removal down to the grinding/polishing transition and to the target.
A laser measuring system uses a relative measuring technique for a system accuracy of $\pm 5 \mu\text{m}$.

If a grinding step starts between 250 μm and 175 μm from the grinding/polishing transition, electronic measurement is not used in this interval, and the laser measuring system is used all the way to the target.

7.3.1 Plane grinding before starting preparation

When you work with critical specimens (small samples, or few samples, or samples with fine geometries), it is recommended that you first plane grind (planarize) the mount before starting the actual preparation. If the sample surface is not plane, this can result in incorrect initial measurements, which can affect the entire preparation.

Procedure

1. Select a **Time mode** method with a #800 SiC paper step.
2. Transfer the method to TargetMaster.
3. Edit the time for the #800 step to 1 minute.
4. Plane grind the specimen.



Note

For critical specimens, establish how the laser measuring system responds to the material: Perform a trial preparation of a similar specimen by using a higher Initial removal rate and a reduced rpm.

7.3.2 Methods - general recommendations

General method

- Plane grinding: #800 SiC Paper.
- Fine grinding (9 µm): MD-Sat, DiaPro, Allegro/Largo.
- Diamond polishing 1 (3 m): MD-Dac, DiaPro Dac.
- Diamond polishing 2 (1 µm): MD-Nap, DiaPro Nap.

Ceramics and PCB

- As for general methods but PG with 20 µm Diamond Pad.

Brittle materials, e.g. silicon

- As for general methods but PG with #1200 SiC Paper.

7.3.3 User methods

You can store up to 20 user methods in each method group.



Note
User methods are not listed alphabetically in TargetDoser.

Each user method has a series of steps that are required for the preparation process. See [Editing method steps ▶ 24](#).

Creating a preparation method

You can create a preparation method in several ways:

- Create a preparation method. See [Creating a method ▶ 21](#).
- Change a preparation method and save it under another name. See [Editing a user method ▶ 23](#)

Storing capacity

You can store a maximum of 200 methods in up to 10 groups. Each group can contain up to 20 methods.

The User Methods screen

1. In the **Method groups** screen, select the correct method group.
2. Press **Enter** to activate the **Method groups** screen.



Creating a method

You can copy a method from the **STRUERS METHODS** folder or from the **USER METHODS** folder, save it under a name of your choice, and adjust it to suit your requirements.

Creating a method not based on Struers methods

1. From the **Main menu** screen, select the **User Methods** screen.
2. Press **Enter** to activate the **Method groups** screen.
3. In the **Method groups** screen, scroll to the group where you wish to create the method.
4. Press **Enter** to open the method group.
5. Scroll to the method named **Empty method**. If the method group is new, only the method named **Empty method** is available.
6. Press **Enter** to edit the method.
7. Set up the method as needed. See [Editing a user method ▶ 23](#).
8. If you wish to rename the method, See: [Renaming a method ▶ 21](#)

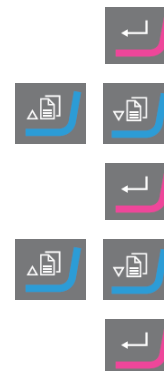

Creating a method based on Struers methods

1. From the **Main menu** screen, select the **Struers Methods** screen.
2. Select the Struers method you wish to base the new method on.
3. Press **F1** to copy the method.
4. Return to the **Main menu** screen.
5. From the **Main menu** screen, select the **User Methods** screen.
6. Press **Enter** to activate the **Method groups** screen.
7. In the **Method groups** screen, scroll to the group where you wish to insert the method.
8. Press **Enter** to open the method group.
9. Press **F2** to insert the method in the group.
10. Press **Enter** to edit the method.
11. Set up the method as needed. See [Editing a user method ▶ 23](#).
12. Rename the method as needed. See: [Renaming a method ▶ 21](#)



Renaming a method

You can rename a method to a name of your choice.

1. From the **Main menu** screen, select the **User Methods** screen.
2. Press **Enter** to activate the **Method groups** screen.
3. In the **Method groups** screen, scroll to the group containing the user method you wish to rename.
4. Press **Enter** to open the method group.
5. Scroll to the method you wish to rename.
6. Open the text editor and rename the method. See: [Renaming a method ▶ 21](#)



Copying a method



Note

When you copy a method, the name of the new method is prefixed with the words **Copy of**. Rename the method as needed.

Copying a method not based on Struers methods

1. From the **Main menu** screen, select the **User Methods** screen.
2. Press **Enter** to activate the **Method groups** screen.
3. In the **Method groups** screen, scroll to the group containing the method you wish to copy.
4. Press **Enter** to open the method group.
5. Scroll to the method you wish to copy.
6. Press **F1** to copy the method.
7. If needed, select another group, where you can insert the copy of the method.
8. Press **F2** to insert the method.
9. Press **Enter** to edit the method.
10. Set up the method as needed. See [Editing a user method ▶ 23](#).
11. If you wish to rename the method, See [Renaming a method ▶ 21](#).



Copying a method based on Struers methods

1. From the **Main menu** screen, select the **Struers Methods** screen.
2. Select the Struers method you wish to base the new method on.

3. Press **F1** to copy the method.
4. Return to the **Main menu** screen.
5. From the **Main menu** screen, select the **User Methods** screen.
6. Press **Enter** to activate the **Method groups** screen.
7. In the **Method groups** screen, scroll to the group where you wish to insert the method.
8. Press **Enter** to open the method group.
9. Press **F2** to insert the method in the group.
10. Press **Enter** to edit the method.
11. Set up the method as needed. See [Editing a user method ▶ 23](#).
12. Rename the method as needed. See [Renaming a method ▶ 21](#)



Editing a user method

You can add up to 20 steps in a user method. Each method step contains a list of process settings which you must define and save before you can add the method step to a user method.

You can copy and insert existing user method steps in user methods:

1. In the Method, mark the step you want to copy.
2. Press the Function key **Copy**.
3. Move to the method to which you want to copy the step, and press the Function key **Insert step**.

You can see the different steps in the **EDIT METHOD** screen.

You can transmit the edited method to TargetMaster from the **EDIT METHOD** screen.

Creating a method step

1. From the **Main menu** screen, select the **User Methods** screen.
2. Press **Enter** to activate the **Method groups** screen.
3. In the **Method groups** screen, scroll to the group containing the user method you wish to edit.
4. Press **Enter** to open the method group.
5. Scroll to the method you wish to edit.
6. Press **Enter** to edit the method.



7. Scroll to **Empty Step**.



8. Edit the step. See [Editing method steps](#) ► 24



9. Save your changes.



The method is automatically sent to TargetMaster if the method is the current method in TargetMaster

Editing method steps

There are two types of polishing surfaces:

- Abrasive
- non-abrasive

The settings shown in the **EDIT METHOD** screen depend on the type of polishing surface you have selected. See also [Defining surfaces, lubricants and suspensions](#) ► 26:

Surface	Suspension	Lubricant
Abrasive	Not required	Water only
Non-abrasive	Diamond suspension. DiaPro or DiaDuo (All-in-one products)	Not required
	Diamond suspension (Water-based)	Water-based
	Diamond suspension (Water-free)	Water-free
	Oxide suspension	Not required

Procedure

1. From the **Main menu** screen, select the **User Methods** screen.
2. Press **Enter** to activate the **Method groups** screen.



3. In the **Method groups** screen, scroll to the group containing the user method you wish to edit.



4. Press **Enter** to open the method group.



5. Scroll to the method you wish to edit.



6. Press **Enter** to edit the method.



7. Scroll to the method step you wish to edit.



8. Press **Enter** to edit the step.



9. Scroll to the setting you wish to edit.



10. Select the correct setting for **Surface**, **Lubricant** and **Suspension**.



11. Press **F1** and **F2** to move up or down the method steps.



12. Press **F4** to save your changes.



The method is automatically sent to TargetMaster if the method is the current method in TargetMaster.

Deleting a method step

1. From the **Main menu** screen, select the **User Methods** screen.

2. Press **Enter** to activate the **Method groups** screen.



3. In the **Method groups** screen, scroll to the group containing the user method you wish to edit.



4. Press **Enter** to open the method group.



5. Scroll to the method you wish to edit.



6. Press **Enter** to edit the method.



7. Scroll to the method step you wish to delete.



8. Press **F4** to delete the step.



9. If you wish to rename the step, select **Rename**.

10. Press **F4** to save your changes.



The method is automatically sent to TargetMaster if the method is the current method in TargetMaster.

Setting Initial removal rate values

When you transfer a method to TargetMaster, the system automatically detects if there are Initial removal rate values available for all steps in the preparation method. If not, a message is shown on the screen of TargetMaster.

You must enter the Initial removal rate values manually for new individual surfaces. If needed, you can edit these values to optimize preparation time.

1. From the **MAIN MENU** screen, select the **Configuration** screen.



2. Press **Enter**.



3. From the **Configuration** screen, select the **Configuration of initial removal rates** screen.

4. Select the rate you wish to change.
5. Open the editor and change the settings.
6. Save the new settings and return to the **Configuration of initial removal rates** screen.
7. Return to the **Main menu** screen.

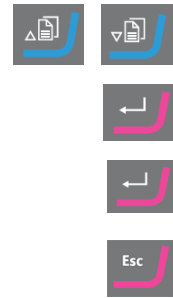

Process mode

1. From the **Main menu** screen, select the **User Methods** screen.
2. Press **Enter** to activate the **Method groups** screen.
3. In the **Method groups** screen, scroll to the group containing the user method you wish to edit.
4. Press **Enter** to open the method group.
5. Scroll to the method you wish to edit.
6. Press **Enter** to edit the method.
7. Scroll to the **Process mode** method step.
8. Press **Enter** to edit the step.
9. Press **Enter** to toggle to the desired mode:
 - **Time mode**
 - **Removal mode**
 - **Target mode**
10. Press **F4** to save your changes.

















The method is automatically sent to TargetMaster if the method is the current method in TargetMaster.

Defining surfaces, lubricants and suspensions

The lists of available consumables depend on the surface you have defined. Use the same method to select surfaces, lubricants and suspensions.

1. From the **Main menu** screen, select the **User Methods** screen.
2. Press **Enter** to activate the **Method groups** screen.
3. In the **Method groups** screen, scroll to the group containing the user method you wish to edit.



4. Press **Enter** to open the method group. 
5. Scroll to the method you wish to edit.  
6. Press **Enter** to edit the method. 
7. Scroll to the method step you wish to edit.  
8. Edit the step. 
9. Scroll to the setting you wish to edit.  
10. Select the correct setting for **Surface**, **Lubricant** and **Suspension**.  
11. Move up or down the list of surface, lubricant or suspension.  
12. Press **Enter** to select the consumable. 
13. Save your changes. 

The method is automatically sent to TargetMaster if the method is the current method in TargetMaster.

Setting dosing levels

When suspensions and/or lubricants are used in a preparation step, you must first select the type of suspension or lubricant, and then the dosing level.

In the **Level** field, you can set two values:

- Pre-dosing: the amount of suspension or lubricant applied onto the surface before the actual step is started.
- Dosing: this is the dosing level used during preparation. Set this level according to the type of surface you have selected.



For **Level** you can set two values: e.g. 2/7 (pre-dosing/dosing).

Option	Pre-dosing	Dosing	Increment
Dosing level	0 - 10	0 - 20	1

Example



The pre-dosing level [e.g. 2]

This value is the pre-dosing level, the amount of suspension or lubricant which is applied to the surface before the actual preparation step is started.

This lubricates the surface to prevent damage from occurring if the specimens were to run on a dry surface.

Applicable values depend on the frequency of use and surface types. For frequently used surfaces, use a lower value than for surfaces used infrequently.



The dosing level [e.g. 7]

This value is the dosing level throughout the preparation. This level is set according to the surface types: soft, napped polishing cloths require more lubricant than hard, flat cloths or fine grinding discs.

Fine grinding discs require a lower dosing level of abrasive than polishing cloths.

Procedure

1. From the **Main menu** screen, select the **User Methods** screen.
2. Press **Enter** to activate the **Method groups** screen.
3. Scroll to the group containing the user method you wish to edit.
4. Press **Enter** to open the method group.
5. Scroll to the method you wish to edit.
6. Press **Enter** to edit the method.
7. Scroll to the method step you wish to edit.
8. Edit the step.
9. Scroll to the setting you wish to edit.
10. Select the correct settings for **Level**.
11. Select the desired setting.
12. Save your changes.



The method is automatically sent to TargetMaster if the method is the current method in TargetMaster.

Changing dosing levels during a process

You can always change dosing levels for suspensions and lubricants during a process. See [Defining surfaces, lubricants and suspensions](#) ► 26.

Deformation in polishing steps

If you observe unacceptable deformation of the sample in any of the polishing steps, either reduce the force or use a less aggressive preparation surface. See [Editing method steps](#) ► 24.

Edit removal step

You can change individual steps in all modes from TargetMaster before you start the process.

1. From the **Main menu** screen, select the **Process** screen.

2. In the **Process** screen, press **F1**.to enter the first edit screen.
3. Enter the edit step screen.
4. Select the step you want to change.
5. Edit the selected step.
6. Change the values of the selected parameter.
7. Accept your changes.
8. Save your changes.



You cannot use the **F1** Edit step button in **Time mode**. To edit a step in this mode, do as follows:

1. Select the step you want to change.
2. Edit the selected step.
3. Change the values of the selected parameter.
4. Accept your changes.



Setting the Time/Accuracy factor setting

Adjust the **Time/Accuracy factor** setting (TAF) to select whether the highest accuracy or the fastest preparation has the highest priority.

Settings	Description
1	Faster preparation, less accuracy
2	Medium speed and accuracy
3	Slower preparation, highest accuracy











Note

For new preparation methods, Struers recommends that you use an initial setting of 3 for **Time/Accuracy factor**.

1. From the **MAIN MENU** screen, select the **Configuration** screen.
2. Activate the **Configuration** screen.



3. Select **Options**.  
4. Activate the **Options** screen. 
5. Select **Time/Accuracy factor**.  
6. Edit the value. 
7. Select the desired **Time/Accuracy factor** setting.  
8. Save the value and return to the **Options** screen. 









Note
 During the preparation process you can see the selected **Time/Accuracy factor** setting in the bottom right hand side of the screen.

Deleting a method

Note
 If the user method you wish to delete is the current user method in TargetMaster, you must first send a different user method to TargetMaster before you can delete the user method in TargetDoser.

Note
 When you delete a user method, it is stored on the clipboard until you delete or copy another user method or step.

Procedure

1. From the **Main menu** screen, select the **User Methods** screen.
2. Press **Enter** to activate the **Method groups** screen. 
3. Scroll to the group containing the method you wish to delete.  
4. Press **Enter** to open the method group. 
5. Scroll to the method you wish to delete.  
6. Press **F3** to delete the method. 
7. If needed, select another group, where you can insert the deleted method.
8. Press **F2** to insert the method. 

7.4 Optimizing a user method

If you are working with silicon

Use #800 SiC Paper for coarse grinding silicon. Continue with #1200 SiC Paper, if needed.

Typically, you can remove up to 1500 μm with one SiC Paper in less than 5 minutes. If you need to remove more than 1500 μm , insert a second #800 SiC Paper step in your method. In this step, you can set the removal rate to your desired value.

If a Diamond Pad is replaced with SiC Paper, the removal rates increase dramatically. Therefore, you must remember to change the Initial removal rate. The default setting is 720 μm , but you must increase it to a minimum of 1300 μm with SiC Paper.

For shortest possible preparation times, the rotational speed of the disc is set to 3000 rpm. Only use a SiC Paper once.

Fine grinding

MD-Largo has excellent properties and is suited for electronics with both very soft and very hard materials in the same matrix. However, over time plastic from the sample chair reduces the performance significantly, unless you clean the MD-Largo after each single use.

As an alternative, MD-Sat (plain woven acetate) is also suited for fine grinding using the same DiaPro, Allegro/Largo suspension as used on MD-Largo.

MD-Sat requires about 10 minutes of running-in before a stable removal rate is achieved, after which it will deliver high removal rates over a long period of time, without any cleaning. Be careful not to over-saturate the cloth with DiaPro, as this can cause aquaplaning of the sample.

Run in the MD-Sat using **Time mode** and an empty sample chair for 10 minutes.

When you replace MD-Largo with MD-Sat, removal rates increase dramatically. Therefore, you must make sure that the Initial removal rate setting is set at 22 $\mu\text{m}/\text{min}$. The recommended IRR-value for MD-Largo remains at 9 $\mu\text{m}/\text{min}$.

In **Target mode**, it is recommended that you set the removal on the fine grinding step to 40 μm , due to the higher removal rate.

7.5 Working with methods in TargetDoser

The software includes a range of Metalog Guide methods, which you can use to set up your preparation methods.

You can work with the following types of methods:

- **STRUERS METHODS**

These methods are predefined. You cannot change the settings. If needed, copy them into the **USER METHODS** folder, and change the settings. See [Editing a user method](#) ► 23 Struers Methods ► 34

- **USER METHODS**

These methods you can copy and change as needed. See [User methods](#) ► 20.

Method groups

In TargetDoser you can create up to 10 method groups where you can store user-defined methods. Each method group can contain up to 20 user methods.

7.5.1 Preparation modes

You can choose between three preparation modes:

- **Time mode**
- **Removal mode**
- **Target mode**

In some cases, it can be necessary to edit steps in Preparation modes. See [Editing method steps](#) ► 24.

7.5.2 Time mode

This mode runs for a specific period of time. Pre-grinding measurements are not necessary, but it can be a good idea to make some basic measurements, as this indicates how much material is actually removed.

Use **Time mode** for preparation steps with very low removal, e.g. oxide polishing or parallel polishing.

The Time mode screen

Before you press the **Start** button, the screen shows the total process time and time per step. If needed, you can edit the time step. See [Edit removal step](#) ► 28

Once preparation has started, the screen shows the time remaining.

7.5.3 Removal mode

If you inspect consecutive layers of a specimen on a regular basis, **Removal mode** will carry out removal of the layers to within an accuracy of +/- 5 µm and stops automatically when the value is reached.

You must enter the removal value manually as the total removal value in the **Process** screen on TargetMaster. See [Manually entering values](#) ► 1.

Using Removal mode

If you have selected a Struers Method or User Method based on **Removal mode**, the screen shows the total removal value and the removal for each step.

Before the process starts, you can edit the removal values by selecting the value.

Once the process has started, the screen indicates the amount of material that still needs to be removed.

Removing thin layers with Removal mode

To obtain a high degree of control, which is required when you work with thin layers of samples, you can reduce the speed and the force. If the mounts are clamped directly into TargetGrip, reduce the rotational speed.

For example, when you are delayering chips, reduce the rpm to a minimum and reduce Force by 25-50%. Increase the Initial removal rate values by 25-50%. If needed, you can lower these values.

Using TargetX/TargetZ with Removal mode

If you do not know the thickness of the layers, you can use TargetZ or TargetX to determine the thickness of the layer to be removed.

1. Make sure that the sample is mounted correctly in TargetGrip. The target area should be as parallel as possible to the reference plane.
2. Align the outermost edge of the sample chair with the vertical crosshair on the screen of the setup station. Set the setting to zero. This becomes the start reference point.
3. Use the controls on the setup station to move the sample until the crosshair is aligned with the target area.
4. The difference between the first measurement value (0) and this value is the removal value. This is the amount of material that is to be removed during the preparation process on TargetMaster.
5. Enter the manually measured removal value as the total removal value in the **Process** screen on TargetMaster. See [Manually entering values ► 1](#).

7.5.4 Target mode

Target mode requires accurate measurements of the distance from the reference edge on TargetGrip to the target area (distance **X** on the illustration).

Use TargetZ or TargetX to perform these measurements.

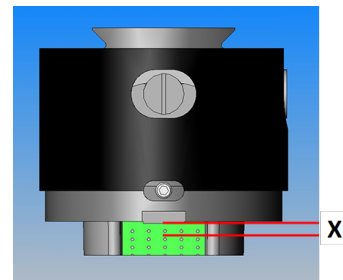

For information on how to use TargetX and TargetZ, see the instruction manuals for these units.

1. Make sure that the sample is mounted correctly in TargetGrip. The target area must be parallel to the reference edge.
2. Align the target area with the vertical crosshair on the screen of TargetX or TargetZ.
3. Set the setting to zero. This is the start reference point. Do not move TargetGrip on the Y-axis after this.
4. Use the controls on TargetX or TargetZ to move the sample until the lines on the screen are aligned with the reference edge on TargetGrip.
5. The difference between the first measurement value and this value is the target value (distance **X** on the illustration).

The Target mode screen

When you select a method based on **Target mode**, the screen shows the distance to the target and the distance per step. You can edit the target distance and removal rate per step at this stage. See [Manually entering values ► 1](#).

When you start the process, the screen shows the remaining distance to the target.

Time remaining to target

You can monitor the remaining distance on the screen while you carry out a preparation based on **Target mode**.

If the distance from the grinding/polishing transition is bigger than 175 µm, the electronic measurement system is used and the screen shows the distance counting down to zero.

Two grinding steps

When you select two consecutive grinding steps, up to 50 µm can be transferred automatically from the first to the second grinding step.

7.5.5 Struers Methods

Struers methods are a set of pre-defined methods, each identified by a letter corresponding to a material type with the same letter in the Metalogram in the Struers Metalog Guide.

You cannot change methods in the **Struers Methods** folder, but you can copy them to the **User Methods** folder, and change them, if needed.

7.5.6 Method groups

You can group preparation methods in method groups. Method groups are methods with common characteristics such as the same class or the same type of materials.

You can copy, move, edit, rename, and delete all the available preparation process data in the **Method groups** screen.

Procedure

1. From the **Main menu** screen, select the **User Methods** screen.
2. Press **Enter** to activate the **Method groups** screen.



Copying a method

1. From the **MAIN MENU** screen, select one of the following screens:

– **STRUERS METHODS**





or

– **USER METHODS**







2. Select the method you wish to use.
3. Copy the method: Press **F1 - COPY**.





4. Press **Enter** to confirm your selection. 
5. If you are copying a method from the **Struers Methods** screen:
 - Press **Back** to return to the **MAIN MENU** screen. 
 - Select the **User Methods** screen. 
6. In the **User Methods** screen, select the field where you want to insert the new method.
7. Insert the method. Press **F2 - Insert**. 
8. If you are using an empty method, the name automatically changes from **Empty method** to **Unnamed method**.
9. Press **Enter** to confirm your selection. 

7.5.7 Creating method groups

1. From the **Main menu** screen, select the **User Methods** screen.
2. Press **Enter** to activate the **Method groups** screen. 
3. In the **Method groups** screen, scroll to **Empty Group**.  
4. Activate the **USER METHODS - Empty Group** screen. 
 - Select **Empty method** and make some changes to the method. See [Creating a method ▶ 21](#).

or

 - Copy a method into the group. Press **F2** to insert a method. See [Creating a method ▶ 21](#). 

When you have changed the **Empty method** or **Empty Group**, the name automatically changes to **Unnamed method** or **Unnamed group**.
5. Use the **Rename** function to give the method or group a name of your choice. 

7.5.8 Deleting a method group



Note

Before you can delete a method group, you must first delete all user methods in this group or move them to another group.

1. From the **Main menu** screen, select the **User Methods** screen.
2. Press **Enter** to activate the **Method groups** screen.
3. In the **Method groups** screen, select the method group you wish to delete.
4. Delete or move all user methods. See [Deleting a method](#) ► 30.
5. Press **F3** to delete the selected group.
6. Press **Enter** to confirm the deletion.



7.6 Transmitting a method to TargetMaster

After editing a method, press **F4** to save the changes you have made. The method is automatically sent to TargetMaster.



Note

You can only transmit a method from TargetDoser to TargetMaster from the **Edit** screen.



Note

When a method is in use in TargetMaster, you can only edit the dosing values.

8 Maintenance and service - TargetDoser

Proper maintenance is required to achieve the maximum up-time and operating lifetime of the machine. Maintenance is important in ensuring continued safe operation of your machine.

The maintenance procedures described in this section must be carried out by skilled or trained personnel.

Safety Related Parts of the Control System (SRP/CS)

For specific safety related parts, see the section "Safety Related Parts of the Control System (SRP/CS)" in the section "Technical data" in this manual.

Technical questions and spare parts

If you have technical questions or when you order spare parts, state serial number and voltage/frequency. The serial number and the voltage are stated on the type plate of the machine.

You can also find this information in the Duramin software by selecting **Tester > Info**.

8.1 General cleaning

To ensure a longer lifetime for your machine, Struers strongly recommends regular cleaning.

**Note**

Do not use a dry cloth as the surfaces are not scratch resistant.

**Note**

Do not use acetone, benzol or similar solvents.

If the machine is not to be used for a longer period of time

- Clean the machine and all accessories thoroughly.

8.2 Daily

- Clean all accessible surfaces with a soft, damp cloth.
- Check and refill the bottles.

8.3 Weekly

- Calibrate TargetZ weekly or after every 10-20 samples.

8.4 Tube cleaning

Always clean the tubes on the TargetDoser when you change bottles.

You must also clean the tubes if you have used oxide polishing media, such as OP-S, in preparation.

8.5 Annually

8.5.1 Changing tubes

The tubes on pump number 5 on TargetDoser are made of silicone because this material has a better resistance against alcohol, but it is not as long-wearing as the material used on the other pumps. Therefore, you must replace the silicone tubes on a yearly basis.

1. Disconnect the doser tubes at the white couplings. The white couplings must stay on the tubes connected to TargetDoser.
2. Press the two tabs [A] and remove the pump from the axle.

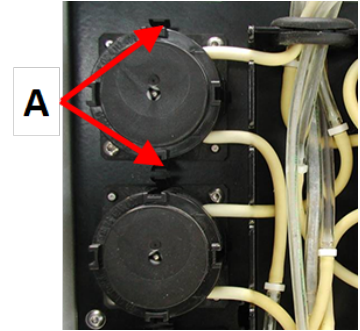

A Tabs

3. Press the two tabs on the pump and remove the bottom cover.

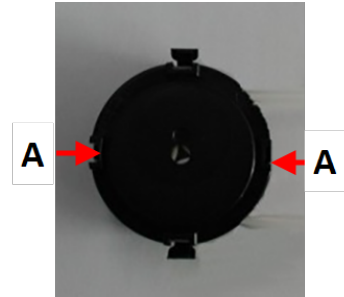

A Tabs

4. Remove the 3 rollers and replace the silicone tube.

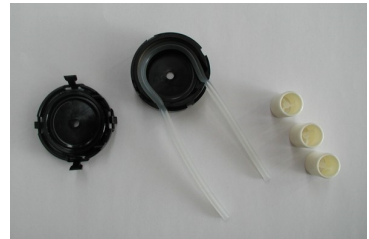

5. Replace the 3 rollers in the pump housing.
6. Re-mount the bottom cover.
7. Re-connect the tubes to the tubes on the TargetDoser. Press the pump back onto the axle.
8. Make sure that the tubes are correctly connected.

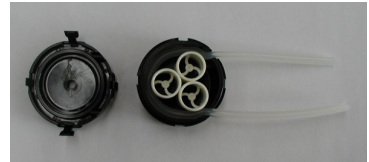

8.6 Spare parts

Technical questions and spare parts

If you have technical questions or when you order spare parts, state serial number and voltage/frequency. The serial number and the voltage are stated on the type plate of the machine.

For further information, or to check the availability of spare parts, contact Struers Service. Contact information is available on Struers.com.

8.7 Disposal



Equipment marked with a WEEE symbol contains electrical and electronic components and must not be disposed of as general waste.

Contact your local authorities for information on the correct method of disposal in accordance with national legislation.



For disposal of consumables and recirculation fluid, follow local regulations.

9 Technical data

9.1 Technical data - TargetDoser

Subject	Specifications	
Safety standards	See the Declaration of Conformity	
Software and electronics	Controls	Touch pad
	Memory	FLASH-ROM/RAM/NV-RAM
Operating environment	Surrounding temperature	5 - 40 °C (41 - 104°F))
	Humidity	35-50 % RH non-condensing
Storage and transport conditions	Surrounding temperature	-20 – 60°C (-4 – 140°F)
	Humidity	35 - 50 % RH non-condensing
Power supply	Voltage/frequency	24 V DC, 1A supplied from TargetMaster
Dimensions and weight	Width	200 mm (8")
	Depth	
	with bottle tray	210 mm (8.3")
	without bottle tray	550 mm (21.7")
	Height	380 mm (15")
	Weight	
	with bottle tray	8.5 kg (18.7 lbs)
	without bottle tray	10 kg (22.1 lbs)
Capacity	Pumps	4 for suspension/lubricant 1 for OP-suspension 1 for soap 1 for alcohol

Subject	Specifications	
Dosing levels	Suspensions	0.2-4.0 ml in 20 steps
	All-in-one suspensions	0.2-12.0 ml in 20 steps
	Lubricants	0.2-12.0 ml in 20 steps
	OP-suspensions	20.0-90.0 ml in 20 steps

9.2 Noise and vibration levels

Noise level	A-weighted sound emission pressure level at workstations	$L_{pA} = 0 \text{ dB(A)}$ (measured value) 4 dB
-------------	--	---

9.3 Diagrams

If you wish to view specific information in detail, see the online version of this manual.

9.3.1 Diagrams - TargetDoser

Title	No.
TargetDoser, Block diagram	15753052 A ▶ 41
TargetDoser, Circuit diagram,	15753161 A ▶ 42

15753052 A

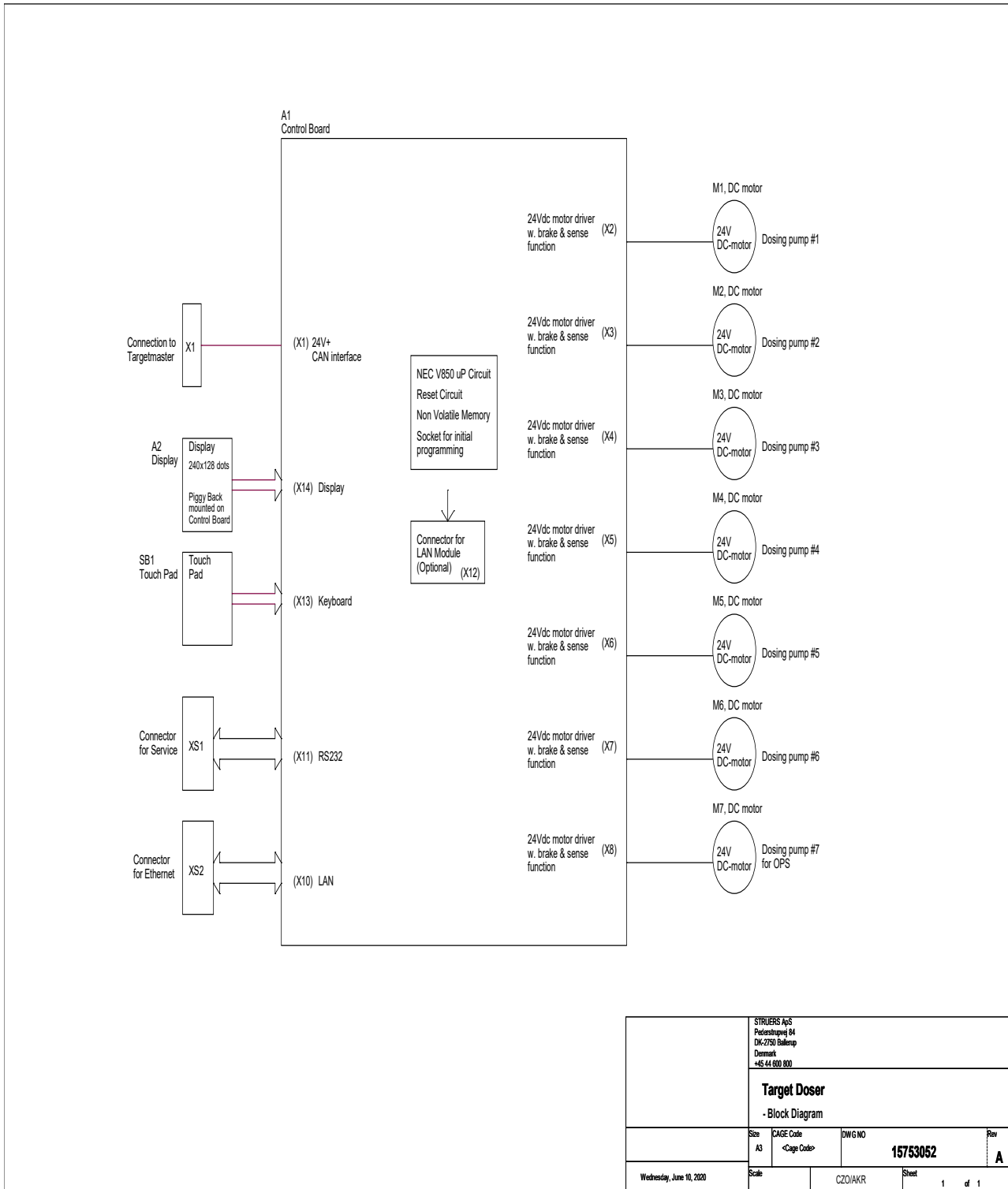

STRUERS ApS Pedersbølvej 84 DK-2750 Ballerup Denmark +45 44 800 800			
Target Doser - Block Diagram			
Size	CAGE Code	DWG NO	Rev
A3	<Cage Code>	15753052	A
Wednesday, June 10, 2020		Scale	Sheet
		CZO/AKR	1 of 1

15753161 A

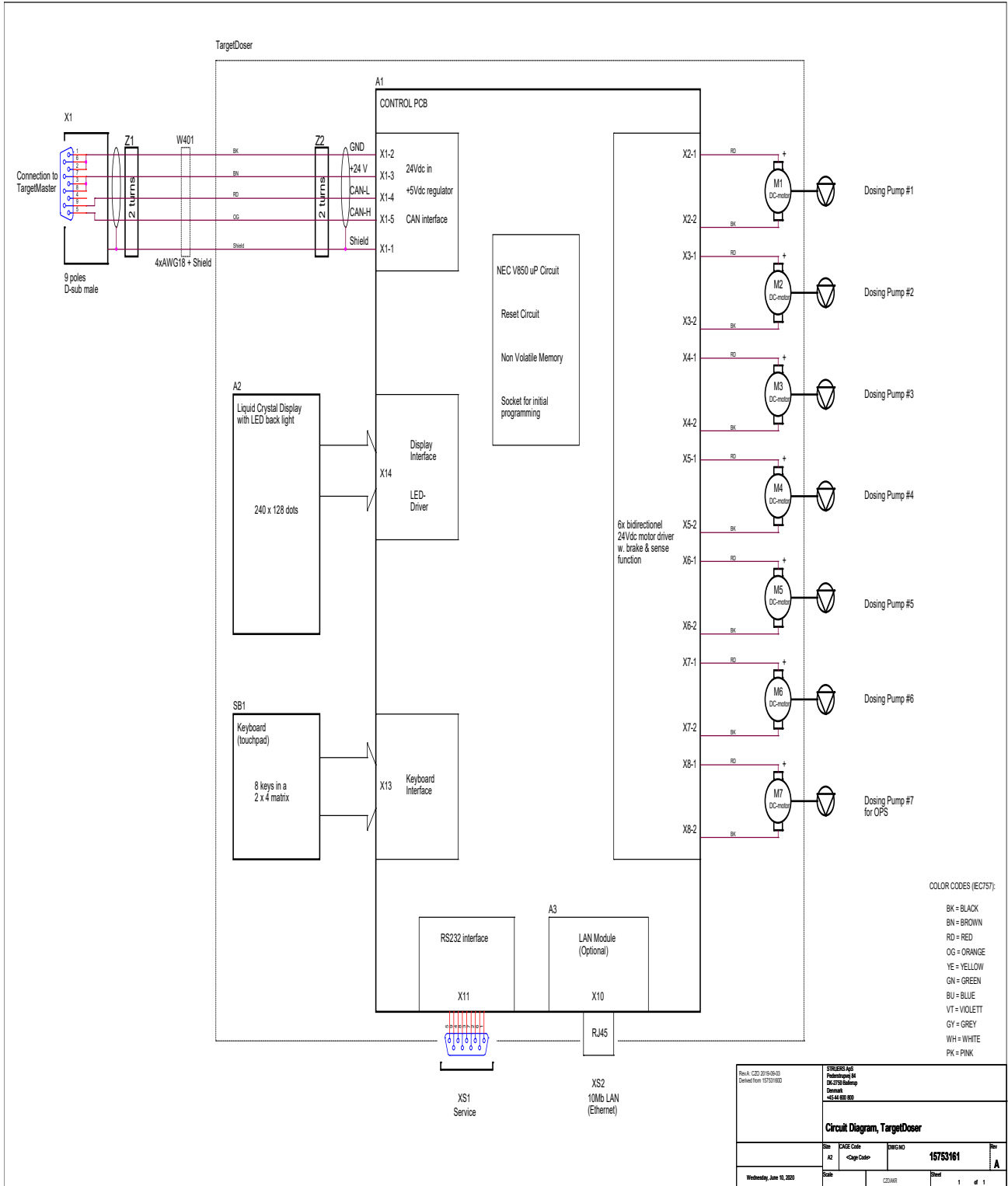

9.4 Legal and regulatory information

FCC notice

This equipment has been tested and found to comply with the limits for a Class B digital device, pursuant to part 15 of the FCC Rules. These limits are designed to provide reasonable protection against harmful interference in a residential installation. This equipment generates, uses and can radiate radio frequency energy and, if not installed and used in accordance with the instructions, may cause harmful interference to radio communications. However, there is no guarantee that interference will not occur in a particular installation. If this equipment does cause harmful interference to radio or television reception, which can be determined by turning the equipment off and on, the user is encouraged to try to correct the interference by one or more of the following measures:

- Reorient or relocate the receiving antenna.
- Increase the separation between the equipment and receiver.
- Connect the equipment into an outlet on a circuit different from that to which the receiver is connected.

10 Manufacturer

Struers ApS
Pederstrupvej 84
DK-2750 Ballerup, Denmark
Telephone: +45 44 600 800
Fax: +45 44 600 801
www.struers.com

Responsibility of the manufacturer

The following restrictions should be observed, as violation of the restrictions may cause cancellation of Struers legal obligations.

The manufacturer assumes no responsibility for errors in the text and/or illustrations in this manual. The information in this manual is subject to change without notice. The manual may mention accessories or parts not included in the supplied version of the equipment.

The manufacturer is to be considered responsible for effects on safety, reliability, and performance of the equipment only if the equipment is used, serviced, and maintained in accordance with the instructions for use.

Struers ApS
Pederstrupvej 84
DK-2750 Ballerup, Denmark

Declaration of Conformity

EU / UE / EL / EC / EE / ES / EÜ / AB

Manufacturer / Производител / Výrobce / Producent / Hersteller / Κατασκευαστής / Fabricante / Tootja / Valmistaja / Fabricant / Proizvođač / Gyártó / Fabbicante / Gamintojas / Ražotājs / Fabrikant / Producent / Fabricante / Producătorul / Výrobca / Proizvajalec / Tillverkare / 販売元 / 제조사 / Produsent / Изготовитель / Imalatçı / 制造商

Декларация за съответствие Prohlášení o shodě Overensstemmelseserklæring Konformitátserklárung Δήλωση συμμόρφωσης Declaración de conformidad Vastavusdeklaratsioon	Vaatimustenmukaisuusvakuutus Déclaration de conformité Izjava o skladnosti Megfelelőségi nyilatkozat Dichiarazione di conformità Atitikties deklaracija Atbilstības deklarācija	Verklaring van overeenstemming Deklaracja zgodności Declaração de conformidade Declarație de conformitate Vyhlásenie o zhode Izjava o skladnosti Intyg om överensstämmelse	適合宣言書 적합성 선언서 Samsvarserklæring Заявление о соответствии Uygunluk Beyanı 符合性声明
--	---	--	---

Name / Име / Název / Navn / Name / Όνομα / Nombre / Nimetus / Nimi / Nom / Naziv / Név / Nome / Pavadinimas / Nosaukums / Naam / Nazwa / Nome / Denumirea / Názov / Ime / Namn / 名前 / 제품명 / Наименование / Adı / 名称	TargetDoser
Model / Модел / Model / Model / Modell / Μοντέλο / Modelo / Mudel / Malli / Modèle / Model / Modell / Modello / Modelis / Modelis / Model / Model / Modelo / Modelul / Model / Model / Modell / モデル / 모델 / Modell / Модель / Model / 型号	TargetDoser
Function / Функция / Functie / Funktion / Funktion / Λειτουργία / Función / Funktsioon / Toiminto / Fönction / Funkcija / Funkció / Funzione / Funkcija / Funkcie / Funkcja / Função / Funcția / Funcia / Funkcija / Funktion / 機能 / 기능 / Funksjon / Назначение / Fonksiyon / 功能	Dosing unit for use with TargetMaster. TargetDoser has 7 peristaltic pumps for dosing diamond suspension lubricant. TargetDoser includes 500 ml and 1000 ml bottles. TargetDoser is controlled via a TargetMaster, a polishing machine for both mounted and unmounted samples that includes a laser with a measuring system of ± 5µm accuracy.
Type / Тип / Typ / Type / Typ / Τύπος / Tipo / Tüüp / Tuuppi / Type / Tip / Típus / Tipo / Tipas / Tips / Type / Typ / Tipo / Tipul / Typ / Tip / Typ / 種類 / 유형 / Type / Тип / Tür / 类型	05756904
Serial no. / Серийн номер / Výrobní číslo / Seriennummer / Seriennummer / Σειριακός αριθμός / N.º de serie / Seerianumber / Sarjanro / No de série / Serijski broj / Sorozatszám / N. serie / Serijos Nr. / Sērijas Nr. / Serien. / Numer serijny / N.º de série / Nr. serie / Výrobné č. / Serijska št. / Seriennummer / シリアル番号 / 일련번호 / Serienr. / Серийный номер / Seri no. / 序列号	

CE
Module H, according to global approach

en We declare that the product mentioned is in conformity with the following directives and standards:	es Declaramos que el producto mencionado cumple con las siguientes directivas y normativas:	hu Kijelentjük, hogy jelen termék megfelel a következő irányelveknek és szabványoknak:	ro Declarăm că produsul menționat este în conformitate cu următoarele directive și standarde:	ko 해당 선언서 상의 제품은 다음 지침 및 기준에 적합함을 선언합니다.
bg Декларираме, че посоченият продукт е в съответствие със следните директиви и стандарти:	et Kinnitame, et nimetatud toode vastab järgmistele direktiividele ja standarditele:	it Dichiariamo che il prodotto citato è conforme ai seguenti standard e direttive:	sk Vyhlasujeme, že uvedený výrobok je v súlade s týmito smernicami a normami:	no Vi erklærer at produktene som er nevnt er i samsvar med følgende direktiver og standarder:
cs Tímto prohlašujeme, že uvedený výrobek je v souladu s následujícími směrnici a normami:	fi Vakuutamme, että mainittu tuote on seuraavien direktiivien ja standardien mukainen:	lt Pareiškiamo, kad nurodytas gaminyis atitinka šias direktyvas ir standartus:	sl Potrjujemo, da je omenjeni izdelek v skladu z naslednjimi direktivami in standardi:	ru Настоящим заявляем, что указанная продукция отвечает требованиям перечисленных далее директив и стандартов:
da Vi erklærer herved, at det nævnte produkt er i overensstemmelse med følgende direktiver og standarder:	fr Nous déclarons que le produit mentionné est conforme aux directives et normes suivantes :	lv Mēs apstiprinām, ka minētais produkts atbilst šādām direktīvām un standartiem:	sv Vi intygar att den angivna produkten överensstämmer med följande direktiv och standarder:	tr Belirtilen ürünün aşağıdaki direktiflere ve standartlara uygun olduğunu beyan ederiz:
de Wir erklären, dass das genannte Produkt den folgenden Richtlinien und Normen entspricht:	hr Izjavljujemo da je spomenuti proizvod sukladan sljedećim direktivama i standardima:	pt Declaramos que o produto mencionado está em conformidade com as seguintes normas e diretivas:	ja 弊社はこの指定製品が以下の指令および基準に適合することを宣言します。	zh 我们特此声明上述产品符合以下指令和标准:
el Δηλώνουμε ότι το εν λόγω προϊόν είναι σύμφωνο με τις ακόλουθες οδηγίες και πρότυπα:				

2006/42/EC	EN ISO 12100:2010, EN 60204-1, EN 60204-1-A1:2009, EN 60204-1/Corr.:2010,
2011/65/EU	EN 50581:2012
2014/30/EU	EN 61000-6-1:2007, EN 61000-6-3:2007, EN 61000-6-3-A1:2011, EN 61000-6-3-A1-AC:2012
Additional standards	NFPA 79, FCC 47 CFR Part 15 Subpart B

Authorized to compile technical file/ Authorized signatory	Christian Skjold Heyde VP Operations	Date: [Release date]
---	---	----------------------

