

AbraPlan-30

Instruction Manual

Original Instructions



CE

Doc. no.: 16297025-01_C_en
Date of release: 2024.12.20

Copyright

The contents of this manual are the property of Struers ApS. Reproduction of any part of this manual without the written permission of Struers ApS is not allowed.

All rights reserved. © Struers ApS.

Table of Contents

1 About this manual	6
1.1 Accessories and consumables	6
2 Safety	6
2.1 Intended use	6
2.2 AbraPlan-30 safety precautions	7
2.2.1 Read carefully before use	7
2.3 Safety messages	8
2.4 Safety messages in this manual	9
3 Get started	11
3.1 Device description	11
3.2 AbraPlan-30 - overview	12
4 Transport and storage	13
4.1 Storage	14
5 Installation	14
5.1 Unpack the machine	14
5.2 Check the packing list	14
5.3 Power supply	15
5.4 Noise	16
5.5 Vibration	16
5.6 Compressed air supply	17
5.7 Connect to an exhaust system	17
5.8 Connecting to the waste water outlet	17
5.9 Connect the recirculation unit	17
5.10 Connecting an external recirculation unit	19
6 Operate the device	20
6.1 Control panel functions	20
6.2 The display	22
6.2.1 Navigating in the display	23
6.2.2 Main menu	23
6.2.3 Changing settings and text	24
6.2.4 Software settings	24
6.3 Configuration	25
6.3.1 Operation mode	25
6.3.2 New pass code	26

6.3.3 Water during grinding	26
6.4 Mounting a grinding stone or diamond grinding disc	27
6.5 Clamp and level the specimens	29
6.6 Insert or remove the specimen holder	30
6.7 Grinding	30
6.7.1 Grinding setup	30
6.7.2 Starting the grinding process	31
6.7.3 Stopping the grinding process	32
6.8 Dressing	33
6.8.1 Dressing setup of diamond tool	34
7 Maintenance and service	36
7.1 General cleaning	36
7.2 Daily	37
7.2.1 Checking the recirculation tank	37
7.3 Weekly	37
7.3.1 Cleaning the bowl	38
7.4 Monthly	39
7.4.1 Cleaning the recirculation unit	39
7.4.2 Changing the cooling fluid	39
7.5 Annually	40
7.5.1 Test the safety devices	41
7.5.2 Emergency stop	41
7.5.3 Safety cover	42
7.6 Spare parts	42
7.7 Service and repair	43
7.7.1 Service of air system	43
7.8 Disposal	43
8 Troubleshooting - AbraPlan-30	44
8.1 Messages and errors - AbraPlan-30	45
8.1.1 Messages	46
8.1.2 Errors	46
9 Technical data	50
9.1 Technical data	50
9.2 Safety Circuit Categories/Performance Level	52
9.3 Noise and vibration levels	53
9.4 Safety Related Parts of the Control System (SRP/CS)	53
9.5 Diagrams	55
9.6 Legal and regulatory information	59

10 Manufacturer	59
Declaration of Conformity	61

1 About this manual

**CAUTION**

Struers equipment must only be used in connection with and as described in the Instruction Manual supplied with the equipment.

**Note**

Read the Instruction Manual carefully before use.

**Note**

If you want to view specific information in detail, see the online version of this manual.

1.1 Accessories and consumables

Accessories

For information about the available range, see the AbraPlan-30 brochure:

- [The Struers Website](http://www.struers.com) (<http://www.struers.com>)

Consumables

The machine is designed to be used only with Struers consumables specifically designed for this purpose and this type of machine.

Other products may contain aggressive solvents, which dissolve e.g. rubber seals. The warranty may not cover damaged machine parts (e.g. seals and tubes), where the damage can be directly related to the use of consumables not supplied by Struers.

For information about the available range, see: [The Struers Website](http://www.struers.com) (<http://www.struers.com>).

2 Safety

2.1 Intended use

The machine is for use in a professional working environment (e.g. a materialographic laboratory).

AbraPlan-30 is for professional automatic plane grinding of materials for further materialographic preparation and inspection.

The device is designed to be used with Struers consumables specially designed for this purpose and this type of device.

The machine must be operated only by skilled/trained personnel.

Do not use the machine for the following	Preparation (grinding or polishing) of materials other than solid materials suitable for materialographic studies. The machine must not be used for any type of explosive and/or flammable material, or materials which are not stable during machining, heating or pressure.
Model	AbraPlan-30

2.2 AbraPlan-30 safety precautions

2.2.1 Read carefully before use

1. Ignoring this information and mishandling of the equipment can lead to severe bodily injuries and material damage.
2. The machine must be installed in compliance with local safety regulations. All functions on the machine and any connected equipment must be in working order.
3. The operator must read the safety precautions and Instruction Manual, as well as relevant sections of the manuals for any connected equipment and accessories. The operator must read the Instruction Manual and, where applicable, the Safety Data Sheets for the applied consumables.
4. Do not use the machine for preparing materials that are flammable or unstable as a result of mechanical processing, pressure or heat during the preparation process (e.g. combustible or explosive materials).
5. Make sure that the actual electrical power supply voltage corresponds to the voltage stated on the name plate of the machine. The machine must be earthed (grounded). Always follow local regulations.
6. This machine must be operated and maintained only by skilled/trained personnel.
7. Struers equipment must only be used in connection with and as described in the Instruction Manual supplied with the equipment.
8. If the equipment is subjected to misuse, incorrect installation, alteration, neglect, accident or incorrect repair, Struers will accept no responsibility for damage to the user or the equipment.
9. Dismantling of any part of the equipment, during service or repair, should always be performed by a qualified technician (electromechanical, electronic, mechanical, pneumatic, etc.)
10. The machine is designed to be used only with Struers consumables specifically designed for this purpose and this type of machine.
11. Note that the machine's center of gravity is located in the upper part of the machine.
12. Make sure that the crossbar is fitted to the machine before lifting it.
13. When you lift the machine with a forklift, always lift it from the front. Never lift it from the side or the rear.
14. Make sure to place the machine on a stable floor that can bear the weight of the machine.
15. Wear suitable gloves to protect fingers from abrasives and warm/sharp specimens.

16. If you observe malfunctions or hear unusual noises, switch off the machine and call technical service.
17. Do not switch the machine on and off more than once every five minutes. Damage to the electrical components could occur.
18. In case of fire, alert bystanders and the fire brigade. Disconnect the electrical power supply. Use a powder fire extinguisher. Do not use water.
19. The machine must be disconnected from the electrical power supply before any service. Wait 5 minutes until residual potential on the capacitors is discharged.
20. Make sure that the specimens are securely fixed to the specimen holder before using the machine. Make sure that you are using the correct screws.
21. Always use working gloves when changing the grinding stone/diamond grinding discs.

2.3 Safety messages

Struers uses the following signs to indicate potential hazards.



ELECTRICAL HAZARD

This sign indicates an electrical hazard which, if not avoided, will result in death or serious injury.



DANGER

This sign indicates a hazard with a high level of risk which, if not avoided, will result in death or serious injury.



WARNING

This sign indicates a hazard with a medium level of risk which, if not avoided, could result in death or serious injury.



CRUSHING HAZARD

This sign indicates a crushing hazard which, if not avoided, could result in minor, moderate or serious injury.



HEAT HAZARD

This sign indicates a heat hazard which, if not avoided, can result in minor, moderate or serious injury.



CAUTION

This sign indicates a hazard with a low level of risk which, if not avoided, could result in minor or moderate injury.



Emergency stop

Emergency stop

General messages



Note

This sign indicates that there is a risk of damage to property, or a need to proceed with special care.



Hint

This sign indicates that additional information and hints are available.

2.4 Safety messages in this manual



CAUTION

Struers equipment must only be used in connection with and as described in the Instruction Manual supplied with the equipment.



ELECTRICAL HAZARD

The machine must be earthed (grounded).
Make sure that the actual electrical power supply voltage corresponds to the voltage stated on the name plate of the machine.
Incorrect voltage can damage the electrical circuit.



ELECTRICAL HAZARD

For electrical installations with Residual Current Circuit Breakers

For AbraPlan-30 a residual current circuit breaker Type B, 30 mA is required (EN 50178/5.2.11.1).

For electrical installations without Residual Current Circuit Breakers

The equipment must be protected by an insulation transformer (double-wound transformer).

Contact a qualified electrician to verify the solution.

Always follow local regulations.



CAUTION

Prolonged exposure to loud noises may cause permanent damage to a person's hearing.

Use hearing protection if the exposure to noise exceeds the levels set by local regulations.



ELECTRICAL HAZARD

Make sure that the electrical power supply voltage corresponds to the voltage stated on the name plate of the pump.
Incorrect voltage can damage the electrical circuit.



CAUTION

The cooling unit tank is very heavy when it is full.



ELECTRICAL HAZARD

The pump of the recirculation cooling unit must be earthed (grounded).
Make sure that the electrical power supply voltage corresponds to the voltage stated on the name plate of the pump.
Incorrect voltage can damage the electrical circuit.



ELECTRICAL HAZARD

Ask a qualified electrician to verify that the external cooling unit can be used with the machine.



CAUTION

The pressure of the cooling fluid supplied to the machine must be max. 2 bar.



CAUTION

Do not use the machine with non-compatible accessories or consumables.



CAUTION

The grinding stone/diamond grinding disc has rough or sharp edges.
Use working gloves to protect fingers and hands.



CAUTION

A specimen holder with specimens can be heavy. Do not release the specimen holder until it is secured in the coupling.
Use working gloves to protect fingers and hands.



CAUTION

Avoid skin contact with the coolant additive.



WARNING

Do not use the machine with defective safety devices.
Contact Struers Service.



CAUTION

Proceed carefully when servicing the air system.
See Air diagram 16292002 in [Diagrams ► 55](#)



WARNING

Safety critical components must be replaced after a maximum lifetime of 20 years.
Contact Struers Service.

3 Get started

3.1 Device description

AbraPlan-30 is a semi-automatic machine for high speed materialographic plane grinding with a 356 mm diameter grinding disc.

A recirculation cooling unit must be connected for supplying cooling water to the grinding process.

The operator selects the grinding surface and the preparation parameters. Stone guard and flushing gun must be in place before the grinding process is started.

The operator starts the process by clamping the specimens in the specimen holder and placing the specimen holder in the machine. The cover is locked when the operator starts the machine, and it remains locked until the motors are stopped.

The operator presses the start button on the control panel to start the grinding process.

The machine stops automatically when the process time or the removal process is completed.

The operator cleans the specimens before the next preparation step or inspection.

We recommend connecting the machine to an exhaust system to remove fumes from the working area.

If the emergency stop is activated, the power to all hazardous moving parts is cut.

3.2 AbraPlan-30 - overview

AbraPlan-30

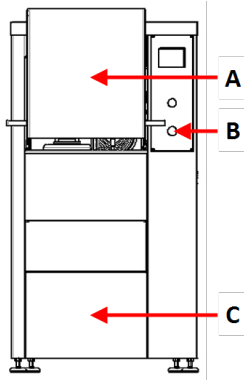

Front view - with safety cover

- A Safety cover
- B Emergency stop
- C Cover plate for compartment containing recirculation cooling unit

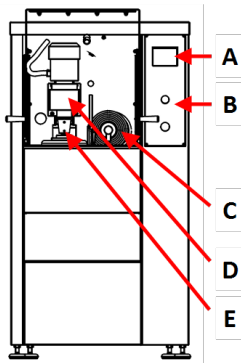

Front view - without safety cover

- A Display
- B Control panel
- C Dresser arm
- D Motor - Specimen holder
- E Quick coupling - Specimen holder

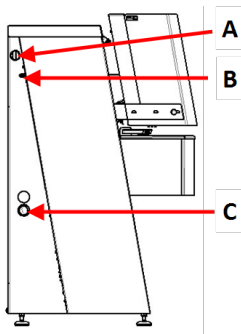

Side view - left

- A Connection for exhaust
- B Compressed air inlet
- C Opening for water outlet hose

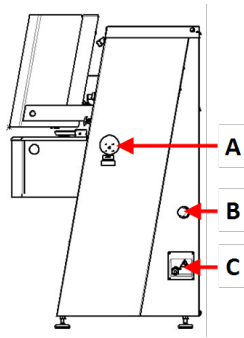
**Side view - right**

- A** Electrical power switch
- B** Opening for water outlet hose
- C** Electrical connection box

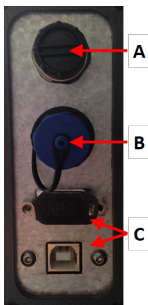
**Electrical connection box**

- A** AUX connector
- B** Beacon connection
- C** Service sockets

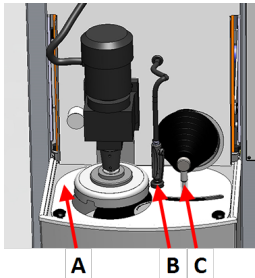
The grinding chamber

- A** Stone guard
- B** Flushing/cooling unit (flushing gun and holder)
- C** Dressing arm

Control panel

See [Control panel functions](#) ► 20.

4 Transport and storage

If, at any time after the installation, you have to move the unit or place it in storage, there is a number of guidelines we recommend that you follow.

- Package the unit securely before transportation. Insufficient packaging could cause damage to the unit and will void the warranty. Contact Struers Service.
- We recommend that you use the original packaging and fittings.

4.1 Storage



Note

We recommend that you keep all original packaging and fittings for future use. Disconnect the unit from the electrical power supply.

- Remove any accessories.
- Clean and dry the unit before storage.
- Place the machine and accessories in their original packaging.

5 Installation

5.1 Unpack the machine



Note

We recommend that you keep all original packaging and fittings for future use.

1. Cut the packing tape on the top of the box.
2. Remove the loose parts.
3. Remove the unit from the box.
4. Unscrew the transport brackets that secure the machine to the pallet.
5. Use a forklift truck to lift the machine from the pallet. Lift the machine from the front.
6. Place the machine on a plane and horizontal floor.
7. Remove the locking pin from the crossbar and remove the bar. Keep the crossbar for use if you need to move the machine.

For details about the weight of this machine, see [Technical data](#) ► 50.

Moving the machine

To move the machine, use a fork-lift truck and a crossbar.

5.2 Check the packing list

Optional accessories may be included in the packing box.

The packing box contains the following items:

Pcs.	Description
1	AbraPlan-30
1	Outlet hose with straight PVC pipe. Diameter: 50 mm. Length: 2.5 m.
1	Inlet hose
1	Hose for emptying the cooling unit tank
2	Hose clamp. Diameter: 11 mm
2	Hose clamp. Diameter: 40-60 mm
1	Hose for compressed air. Length: 2 m
1	Hose connection for compressed air. Diameter: 8 mm
1	Rubber disc. Diameter: 350 mm
1	Flange
1	Bolt M12 for grinding stone flange
1	Allen key, 8 mm
1	Fork spanner, 24 mm
1	Instruction Manual set

5.3 Power supply



ELECTRICAL HAZARD

The machine must be earthed (grounded).
Make sure that the actual electrical power supply voltage corresponds to the voltage stated on the name plate of the machine.
Incorrect voltage can damage the electrical circuit.



ELECTRICAL HAZARD

For electrical installations with Residual Current Circuit Breakers

For AbraPlan-30 a residual current circuit breaker Type B, 30 mA is required (EN 50178/5.2.11.1).

For electrical installations without Residual Current Circuit Breakers

The equipment must be protected by an insulation transformer (double-wound transformer).

Contact a qualified electrician to verify the solution.

Always follow local regulations.

Procedure

For specifications see the section Technical data.

1. Open the electrical connection box. **A**
2. Connect a 4-lead or 5-lead cable as shown.

- PE Earth (ground)
- N Neutral (not used internally)
- L1 Phase
- L2 Phase
- L3 Phase

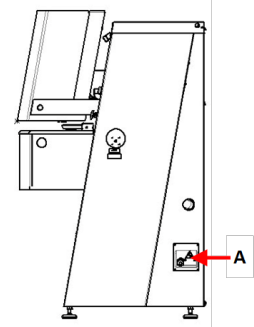

EU cable	
L1	Brown
L2	Black
L3	Black or Gray
Earth (ground)	Yellow/Green
Neutral	Blue

UL cable	
L1	Black
L2	Red
L3	Orange/Turquoise
Earth (ground)	Green (or Yellow/Green)
Neutral	White

The other end of the cable can be fitted with an approved plug or hard-wired into the power supply according to the electrical specifications and local regulations.

5.4 Noise

For information on the sound pressure level value, see this section: [Technical data ▶ 50](#)



CAUTION

Prolonged exposure to loud noises may cause permanent damage to a person's hearing. Use hearing protection if the exposure to noise exceeds the levels set by local regulations.

5.5 Vibration

For information on the total vibration exposure to hand and arm, see this section: [Technical data ▶ 50](#)

5.6 Compressed air supply

For specifications, see [Technical data](#) ► 50.

1. Connect the compressed air hose to the compressed air inlet on the machine.
2. Connect the air hose to the compressed air supply.
3. Secure the connections with hose clamps.

5.7 Connect to an exhaust system

For specifications, see [Technical data](#) ► 50.

Struers recommends that the machine is connected to an exhaust system.

1. Connect a 52 mm pipe to the exhaust outlet on the machine.
2. Connect the other end of the pipe to the exhaust system.

5.8 Connecting to the waste water outlet

If you are connecting the machine to the waste water drain

1. The machine is delivered with a water outlet hose.
2. Lead the water outlet hose out of the machine through one of the openings in the sides of the machine.
3. Make sure that the hose slopes downward towards the waste water drain throughout its entire length. If needed, shorten the hose.

If you are connecting the machine to a recirculation unit

Usually, the machine is connected to the recirculation tank or to an external recirculation unit.

Recirculation unit: See [Connect the recirculation unit](#) ► 17

External recirculation unit: See [Connecting an external recirculation unit](#) ► 19

5.9 Connect the recirculation unit

To ensure optimal cooling, mount a recirculation cooling unit on the machine.



Note

Before you connect the recirculation unit to the machine, you must prepare it for use. See the Instruction Manual for this unit.



ELECTRICAL HAZARD

Make sure that the electrical power supply voltage corresponds to the voltage stated on the name plate of the pump.
Incorrect voltage can damage the electrical circuit.

Filling the recirculation tank

1. Before you fill the tank, make sure that there is room under the machine for the recirculation unit to slide in easily. If this is not the case, use the adjustable feet to adjust the height of the machine.
2. Make sure that the recirculation unit is placed correctly under the machine:

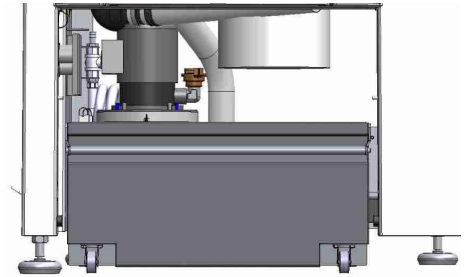

- The wheels of the unit must be in line with the sides of the compartment so that you can move the unit into position without having to wiggle it from side to side.
- The pump must be placed on the left hand side and close to the rear end of the recirculation unit.



Note

To prevent corrosion, Struers recommends using a Struers additive in the cooling water. For more information, see the additive container.

3. Line the tank with a clean plastic liner.



CAUTION

The recirculation tank is very heavy when it is full.



Note

Do not overfill the tank.
Avoid spilling when you move the tank.

4. Fill up the tank with cooling fluid. Make sure that the water/additive ratio is correct.

Connecting the unit to the machine

1. Connect the water inlet hose to the quick coupling on the recirculation pump.
 - A** Electrical power socket - not shown
 - B** Water inlet hose - to machine
 - C** Recirculation pump
 - D** Quick coupling - on pump
2. Insert the water outlet hose from the machine into the large hole of the filter unit. If needed, shorten the hose.
3. Connect the cable from the recirculation pump to the electrical power socket of the recirculation unit inside the compartment.
4. Make sure that the direction of the flow is as stated with an arrow on the pump. If the direction is incorrect, switch two of the phases:
 - EU cable: switch two of the phases.
 - UL cable: switch phases L1 and L2.
5. Push the unit into place in the compartment under the machine.

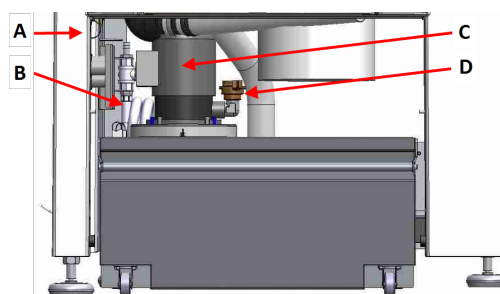

5.10 Connecting an external recirculation unit

1. Guide the water outlet hose through the opening on the left or right side of the machine to the recirculation unit.
2. Connect the water outlet on the pump to the water inlet hose.



ELECTRICAL HAZARD

Make sure that the electrical power supply voltage corresponds to the voltage stated on the name plate of the pump.
Incorrect voltage can damage the electrical circuit.



CAUTION

The pressure of the cooling fluid supplied to the machine must be max. 2 bar.

3. Connect the cable from the external pump to the electrical power socket of the recirculation unit inside the compartment.
Wiring: For specifications see the section Technical data.

Note
If you are using the AUX connection, contact Struers Service more information on the connection and the required flow.

4. Connect the external pump control to the AUX connection on the rear of the machine. **A**

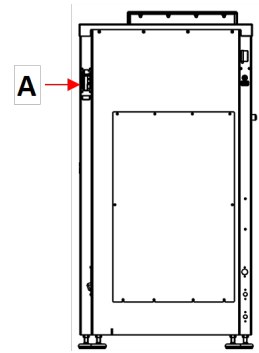







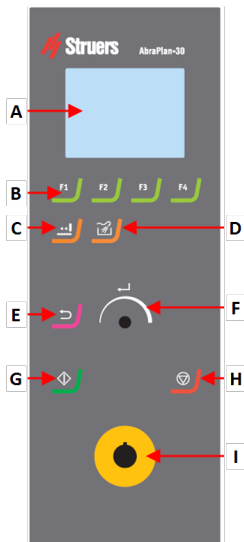

6 Operate the device



CAUTION
Do not use the machine with non-compatible accessories or consumables.

6.1 Control panel functions



- A** Display
- B** Function keys - **F1** to **F4**
- C** **Dress** function
- D** **Flush** function
- E** **Back** function
- F** Turn/push knob
- G** **Start** button
- H** **Stop** button
- I** Emergency stop button

Button	Function
 to 	Function key <ul style="list-style-type: none"> Press this button to activate controls for various purposes. See the bottom line of the individual screens.
	Dress <ul style="list-style-type: none"> Press this button to dress the grinding stone.
	Flush <ul style="list-style-type: none"> Press this button to start and stop the flushing gun.
	The Turn/push knob knob <ul style="list-style-type: none"> Turn the Turn/push knob knob to move the focus on the screen and change steps and setting. Press to toggle when only 2 options are available. Press the Turn/push knob knob to select a function or save a selected setting.
	Back <ul style="list-style-type: none"> Press this button to return to the previous screen or to cancel functions/changes.
	Start <ul style="list-style-type: none"> Starts the preparation process.
	Stop <ul style="list-style-type: none"> Stops the preparation process.

Button	Function
	<p>Emergency stop</p> <div style="border: 1px solid blue; padding: 10px;"> <p>Note  Do not use the emergency stop for operational stop of the machine during normal operation. Before you release the emergency stop, investigate the reason for activating the emergency stop and take any necessary corrective action.</p> </div>

6.2 The display

Note
 The screens shown in this manual may differ from the actual screens in the software.

The display is the user-interface to the software.

When you switch on the machine, the display shows the configuration and the version of the installed software.

The display is divided into some main areas. See this example.

A Title bar

The title bar shows the function you have selected.

B Information fields

These fields show information about the selected function. In some fields you can select and change the value.



C Function key options

The functions shown depend on the screen that is displayed.

Sound	Description
Short beep	<p>A short beep, when you press a key, indicates that the selection is confirmed.</p> <p>You can enable or disable the beep: select Configuration.</p>
Long beep	<p>A long beep, when you press a button, indicates that the key cannot be activated at the moment.</p> <p>You cannot disable this beep.</p>

Standby mode

To increase the lifetime of the display, the backlight is dimmed automatically if the machine has not been used for a while. (10 min)

- Press any key to reactivate the display.

6.2.1 Navigating in the display



The Turn/push knob

Use this knob on the control panel to select menu items.

- Turn the knob to select a menu, a method group or to change a value.
- Press the knob to enter a field or activate the selection.
- Turn the knob to increase or decrease the numeric value, or to toggle between two options.
 - If there are only two options, press the knob to toggle between the two options.
 - If there are more than two options, a pop-up box is shown.

The Back button



Use this button on the control panel to return to previous functions or values.

- Press the button to return to the main menu.
- Press the button to return to the last function or value.
- Press the button to cancel changes.

6.2.2 Main menu

From **Main menu** you can choose between the following options:



- **Grinding**



- **Dressing**

You can also access the maintenance and configuration screens.



- **Maintenance**



- **Configuration**

6.2.3 Changing settings and text

Changing text

To change a text value, select the field for entering the text.

1. Press the **Turn/push knob** knob to activate the text editor.
2. If needed, use the **Upper case/Lower case** arrow at the bottom of the screen to switch between upper case and lower case letters.
3. Enter the desired text.
4. Navigate to select **Save & Exit**.
5. Press the knob to exit the screen.



Change the settings

To change a setting, select the field for changing the setting.

1. Turn the **Turn/push knob** knob to go to the field where you wish to change the setting.
2. Press the **Turn/push knob** knob to enter the field.
 - **More than two options:**
Turn the **Turn/push knob** knob to scroll up or down in a list of values.
 - **Two options:**
Press the **Turn/push knob** knob to toggle between the options.
3. Navigate to select **Save & Exit**.
4. Press the knob to exit the screen.

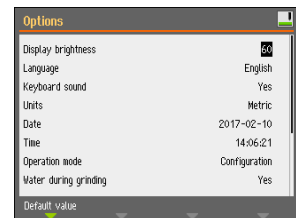

6.2.4 Software settings

Start-up - the first time

For instructions on how to navigate in the display, see [Navigating in the display ► 23](#)

Select language

1. Select the language you wish to use. If needed, you can change the language at a later date.
 - From the **Main menu** select **Configuration > Options > Language**.



2. **Date**
You will be prompted to set the date.



3. **Time**
You will be prompted to set the time.



Start-up - daily operation

When you switch on the machine, the screen that was shown when the machine was switched off is shown just after the start-up screen.

6.3 Configuration

From the **Configuration** menu you can access a number of settings and parameters.

1. From the **Main menu**, select **Configuration**.
2. From the **Configuration** menu, select:



- **Options** for general settings.

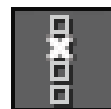

6.3.1 Operation mode

User levels

You can select three different user levels as operation mode.

Operation mode	Grinding	Change the settings	Configuration functions
Production	You can select and view settings.	You can select and view settings.	You can edit some settings.
Development	You can select, view and edit settings.	You can select, view and edit settings.	You can edit some settings.
Configuration	You can select, view and edit settings.	You can select, view and edit settings.	You can edit all settings.

Change operation mode

To change the operation mode, do the following:

1. From the **Main menu** select **Configuration > Options > Operation mode**.
2. Enter the pass code. See [New pass code ▶ 26](#).
3. When the **Select operation mode** dialog is shown, select the desired operation mode and confirm your selection.

6.3.2 New pass code

When you access the menu, you will be prompted to enter a pass code. The default pass code is '2750'.

Changing the pass code

You can change the pass code from the **Operation mode** menu.



Note

Make a note of the new pass code.

To change the pass code, do the following:

1. From the **Main menu** select **Configuration > Options**.
2. Select the field for entering the pass code.
3. When the **Enter pass code** dialog is shown, enter the current pass code. The default pass code is '2750'.
4. Change the pass code and confirm your selection.

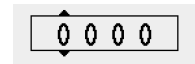

6.3.3 Water during grinding

To enable or disable water during grinding, do the following:

1. From the **Main menu** select **Configuration > Options > Water during grinding**.
Set the value to **Yes** or **No**

6.4 Mounting a grinding stone or diamond grinding disc



CAUTION

Do not use the machine with non-compatible accessories or consumables.



CAUTION

The grinding stone/diamond grinding disc has rough or sharp edges.
Use working gloves to protect fingers and hands.

1. From the **Main menu** select **Change grinding disc**.



2. Follow the on-screen instructions.
3. From the list **Select grinding disc**, select the grinding stone or diamond grinding disc you wish to mount.
 - UGS = User Grinding Stone
 - UDGD = User Diamond Grinding Disc



Note

If the dressing arm is used with the diamond tool on a diamond grinding disc this will destroy the disc or the diamond tool.

Therefore, make sure that you select the correct grinding stone/diamond grinding disc.

Dressing is automatically disabled when a diamond grinding disc is selected.

If the dressing arm is down, it will be raised to its "park" position.

6 Operate the device

4. Make sure that the specimen holder motor is fully raised.
5. Open the cover to the grinding chamber.
6. Move the flushing gun out of the way.
7. Unscrew the 2 finger screws (A).
8. Carefully lift the stone guard up and away, towards the front of the machine.

Hold the stone guard by the dressing arm groove.

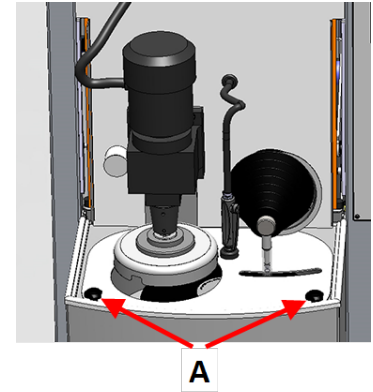

9. Remove the current grinding stone or diamond grinding disc, if one is mounted.
10. Before you mount the new grinding stone or diamond grinding disc, make sure of the following:
 - The grinding stone or diamond grinding disc must be intact.
 - The grinding stone or diamond grinding disc must be dry when you mount it.
 - The flange must be clean and smooth.
11. Assemble the grinding stone or diamond grinding disc on the base plate.

- A** Base plate
- B** Rubber disc
- C** Grinding stone/Diamond grinding disc
- D** Fastening flange and cardboard washer

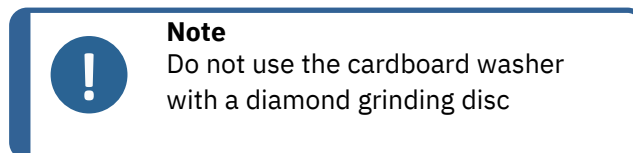

- E** Fastening bolt

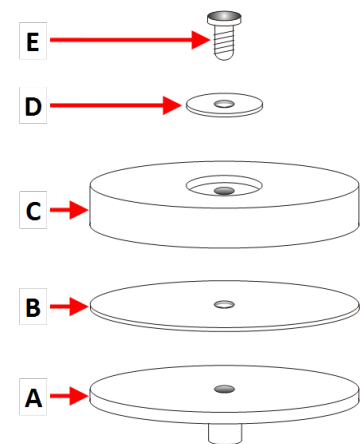

12. Mount the bolt.
13. Use an Allen key to fasten the bolt with a force of minimum 8 Nm (5.9 lbf-ft), maximum 10 Nm (7.4 lbf-ft).

Do not tighten the bolt too much as this can damage the grinding stone or diamond grinding disc.
14. Remount the stone guard and tighten the 2 finger screws.
15. Place the flushing gun in the holder.
16. Lower the cover and follow the on-screen instructions.

If you have mounted another grinding stone, the following message is shown:

The dresser needs to perform a surface search.

Press Enter to start the procedure

17. Press the Turn/push knob knob to continue.
A surface search starts automatically to determine the height of the stone and the reference position.
18. When the grinding stone or diamond grinding disc change is complete, you can do the following:
 - Press the Turn/push knob knob to confirm that you have finished the changing procedure.
 - Press F1 to select **Spin test**.

This test checks the integrity of the stone or disc while the stone or disc rotates.

You will see the following message:

Close the cover and press START to start the spin test.

6.5 Clamp and level the specimens

The specimens must be evenly distributed in the specimen holder. They must be of approximately the same size and weight.

The specimen holder must be balanced. If it is not, it will result in excess vibration during grinding.

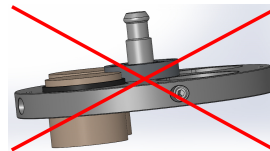
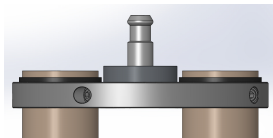

1. Place at least three specimens symmetrically around the center of the specimen holder so that you achieve an even and balanced rotation.
2. Tighten the screws carefully to clamp the specimens in place.
3. Always choose a length of screw that leaves as little as possible of the screw projecting from the specimen holder and that uses the whole length of the thread inside the specimen holder.
4. Make sure that all specimens are securely fixed.



Hint

If you are using a Uniforce leveling device, see the instructions manual for this device.

6.6 Insert or remove the specimen holder



CAUTION

A specimen holder with specimens can be heavy. Do not release the specimen holder until it is secured in the coupling.
Use working gloves to protect fingers and hands.

Insert the specimen holder

1. Place the specimen holder under the quick coupling and support it with your fingers.
2. Press and hold down the flange of the column while you guide the pressure tap of the specimen holder into the coupling.
3. Release the flange carefully.
4. Rotate the specimen holder until the three pins engage with the corresponding holes.
5. Make sure that the specimen holder is securely fixed in the coupling.



Remove the specimen holder

1. Support the specimen holder with your fingers.
2. Press and hold down the flange while you press the specimen holder slightly upwards. At the same time, use the heel of your hand to press and hold down the flange.
3. Support the specimen holder with one hand while you lower it to release it from the coupling.
4. Release the flange and remove the specimen holder.

6.7 Grinding

6.7.1 Grinding setup



Selecting the grinding mode

The settings defined in the **Grinding setup** menu are saved in the software if the power to the machine is interrupted.

1. From the **Main menu** select **Grinding**.
2. Select the grinding mode.





The following modes are available:

- **Removal**
Select a specific amount of material to be removed from the specimens. 
- **Time**
Select a specified length of time for the process. 
- **Removal-Time**
Select a combination of **Removal** and **Time** 

Removal-Time is used when absolute planeness is required:

- A specified amount of material is removed.
- The stone is dressed.
- A very short grinding step on the newly dressed, plane stone is carried out.

This ensures a maximum planeness after the required amount of material has been removed.

3. Select the grinding stone/diamond grinding disc you wish to use. 
4. Set the force you wish to apply. 

The Removal process time

The **Removal** process times out after 15 minutes.

If the set amount of material has not been removed within this time, the process stops automatically.

If a low removal rate is detected in a 5 minute period, a pop-up is shown:

The removal rate is too low. Time limit was exceeded.

1. Press **F1** to stop the process.
2. Change the settings for removal and force to continue grinding, or press the Turn/push knob knob to continue the process for 1 hour.

6.7.2 Starting the grinding process

1. Close the cover of the machine.
2. When you have selected the grinding mode, make sure that the settings are correct.

- 3. Press the Start button.



Cooling

The recirculation pump starts automatically when the process is started.

The grinding process

The display shows the status of the process as shown in this example.

- A** Grinding mode
- B** Material remaining to be removed
- C** Force applied on the specimen holder
- D** Load on the main motor

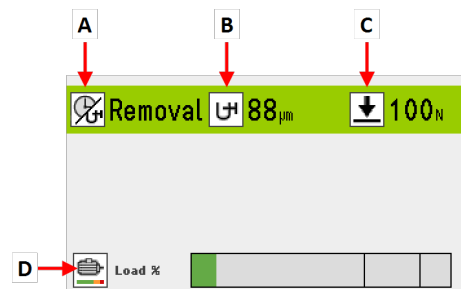

6.7.3 Stopping the grinding process

The process stops automatically when the set time has elapsed or the specified amount of material has been removed.

The grinding stone stops rotating and the specimen holder returns to its start position.

If needed, you can stop the process earlier.

Stopping the machine

- Press the **Stop** button.



The process is paused.

To stop the process completely:

- Press the **Stop** button again



**Note**

If you pause the process in **Removal** mode, the specific reference position may be lost. To ensure accurate results, stop the process completely, and start a new process with a new reference position.

6.8 Dressing

Dressing functions

Make sure that the grinding stone is dressed at regular intervals to keep the stone plane and sharp. A diamond tool is used for automatically dressing the grinding stone.



**Note**

Always select the correct setup when you insert or change the grinding stone.

**Note**

Never use the dressing arm with the diamond tool on a diamond grinding disc. It can destroy the disc and the diamond tool.

A small icon in the top right corner of the software screen shows the status of the grinding medium.

Icon	Function
	The grinding stone has been used but not dressed.
	The grinding stone has just been dressed.
	A diamond grinding disc is mounted.

Automatic dressing

It is recommended that the automatic dressing function is enabled so that the grinding stone is dressed automatically during the grinding process.

Manual dressing

1. Press **Dress** to dress the grinding stone.

This function applies in the **Grinding setup** screen, the **Dressing setup** screen, or during a process.



Dressing a diamond grinding disc

To dress a diamond grinding disc:

1. Mount 3 aluminum oxide dressing sticks in a specimen holder and grind for a few seconds. See the manual for the aluminum oxide dressing sticks.

6.8.1 Dressing setup of diamond tool

You can set up the dressing function.

Setting	Description
Dresser step (multiple sweeps >50 μ)	<p>The distance the dresser is moved down for every step.</p> <p>Select a value between 10 μm and 200 μm in steps of 10 μm. Use the smallest step size possible.</p> <p>Multiple sweeps are used for steps > 50 μm</p> <div style="border: 1px solid blue; padding: 5px; margin-top: 10px;"> <p>Note</p> <p>During the dressing process you can listen to make sure that the dresser is in contact with the grinding stone across the whole surface.</p> <p>If the stone is uneven, increase the dresser step.</p> </div>
Dresser speed (1=low ... 10=high)	<p>The speed of the dresser when it moves across the stone. Set a value between 1 and 10.</p>
Automatic dressing during process	<p>Select Yes to enable automatic dressing, particularly if Removal mode is used.</p>

Setting	Description							
Dressing mode	This setting is available when Automatic dressing during process is set to Yes . Dressing mode can be set to either Removal or Time , depending on the grinding mode.							
	<table border="0"> <tr> <td data-bbox="852 439 970 465">Removal</td> <td data-bbox="1121 439 1406 573">Dressing starts automatically when the removal rate decreases to a certain level.</td> </tr> <tr> <td data-bbox="852 591 922 618">Time</td> <td data-bbox="1121 591 1342 685">The stone will be dressed at regular intervals.</td> </tr> </table>	Removal	Dressing starts automatically when the removal rate decreases to a certain level.	Time	The stone will be dressed at regular intervals.			
	Removal	Dressing starts automatically when the removal rate decreases to a certain level.						
	Time	The stone will be dressed at regular intervals.						
<table border="0"> <tr> <td data-bbox="852 725 1043 752">Grinding mode</td> <td data-bbox="1121 725 1310 752">Dressing mode</td> </tr> <tr> <td data-bbox="852 770 970 797">Removal</td> <td data-bbox="1121 770 1334 797">Removal or Time</td> </tr> <tr> <td data-bbox="852 815 922 842">Time</td> <td data-bbox="1121 815 1185 842">Time</td> </tr> <tr> <td data-bbox="852 860 1043 887">Removal-Time</td> <td data-bbox="1121 860 1334 887">Removal or Time</td> </tr> </table>	Grinding mode	Dressing mode	Removal	Removal or Time	Time	Time	Removal-Time	Removal or Time
Grinding mode	Dressing mode							
Removal	Removal or Time							
Time	Time							
Removal-Time	Removal or Time							
When Dressing mode is set to Removal , you can adjust Dresser sensitivity .								
	Select a value between 1 and 5. <ul style="list-style-type: none"> • High sensitivity: The stone is dressed as soon as the removal rate decreases. Grinding time is as short as possible. • Low sensitivity: Removal decreases even more before the stone is dressed. Grinding time is longer. The lifetime of the grinding stone is longer. 							
Dressing interval	This setting is available when Dressing mode is set to Time . Select a value between 0:10 and 5:00 minutes.							
Dressing during process	Dressing while the specimen holder is on the grinding stone. It is used in grinding very hard materials where frequent dressing is necessary. <table border="0"> <tr> <td data-bbox="852 1680 906 1706">Yes</td> <td data-bbox="970 1680 1382 1747">Dressing with pre-set force on the specimen holder.</td> </tr> <tr> <td data-bbox="852 1765 896 1792">No</td> <td data-bbox="970 1765 1394 1859">Dressing with reduced force on the specimen holder. The holder is raised slightly during dressing.</td> </tr> </table>	Yes	Dressing with pre-set force on the specimen holder.	No	Dressing with reduced force on the specimen holder. The holder is raised slightly during dressing.			
Yes	Dressing with pre-set force on the specimen holder.							
No	Dressing with reduced force on the specimen holder. The holder is raised slightly during dressing.							

Setting	Description
Automatic dressing after process	Automatically dresses the stone after every process. Yes If Time mode is selected, it ensures that the grinding stone is sharp when the process is started. No If Removal mode is selected, the stone is dressed when it is necessary.
Remaining height of stone	The value shows how much grinding stone is available.

Function keys	
F1	Redetect the surface, if there is a high rate of wear on the grinding stone.
F4	Change the grinding stone.

7 Maintenance and service

Proper maintenance is required to achieve the maximum up-time and operating lifetime of the machine. Maintenance is important in ensuring continued safe operation of your machine.

The maintenance procedures described in this section must be carried out by skilled or trained personnel.

Safety Related Parts of the Control System (SRP/CS)

For specific safety related parts, see the section "Safety Related Parts of the Control System (SRP/CS)" in the section "Technical data" in this manual.

Technical questions and spare parts

If you have technical questions or when you order spare parts, state serial number and voltage/frequency. The serial number and the voltage are stated on the name plate of the machine.

7.1 General cleaning

To ensure a longer lifetime for your machine, we strongly recommend regular cleaning.



Note

Do not use a dry cloth as the surfaces are not scratch resistant.
Grease and oil can be removed with ethanol or isopropanol.

**Note**

Do not use acetone, benzol or similar solvents.

If the machine is not to be used for a longer period of time

- Clean the machine and all accessories thoroughly.

7.2 Daily

- Clean all accessible surfaces with a soft, damp cloth.

Recirculation unit

See the manual supplied with the specific equipment.

- Check the level of the cooling fluid after 8 hours of use, or at least once a week. If needed, fill up the tank with more cooling fluid.
- Check the filters. Clean the filters, if needed.

7.2.1 Checking the recirculation tank

1. Check and, if necessary, change the cooling fluid.

**Note**

If the cooling fluid is contaminated by algae or bacteria, replace the cooling fluid immediately.

2. If the pump cannot reach the cooling fluid, refill the unit.
3. Change the cooling fluid if it is dirty. See [Changing the cooling fluid ► 39](#).

7.3 Weekly

Clean the machine regularly to avoid damage caused by abrasive grains or metal particles.

1. Clean all painted surfaces and the control panel with a soft damp cloth and common household detergents. For heavy duty cleaning, use a heavy duty cleaning agent such as Solopol Classic.

Cleaning the safety cover

1. Clean the safety cover with a soft damp cloth and a common household anti-static window cleaner.

**Note**

Make sure that no detergent or cleaning agent is flushed into the cooling unit tank, as this will cause excess foaming.

Recirculation unit

See the manual supplied with the specific equipment.

- Clean the recirculation unit. See [Cleaning the recirculation unit ▶ 39](#).
- Clean the recirculation unit tank. See [Cleaning the recirculation unit ▶ 39](#).
- Fill up the recirculation unit tank. See [Changing the cooling fluid ▶ 39](#)

7.3.1 Cleaning the bowl

1. From the **Maintenance** menu select **Cleaning**.
2. If the dressing arm is down, press **F1** to lift it to its top position.
3. Make sure that the specimen holder motor is raised to its top position.
4. Open the cover.
5. Move the flushing gun out of the way.
6. Unscrew the two finger screws.
7. Grip the stone guard by the dressing arm groove and carefully lift the stone guard up and out to the front of the machine.
8. Remove the stone guard.
9. Remove any debris that may have accumulated at the bottom of the bowl.

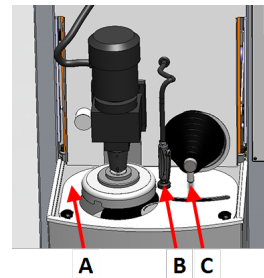

- A** Stone guard
- B** Flushing unit (flushing gun and holder)
- C** Dressing arm

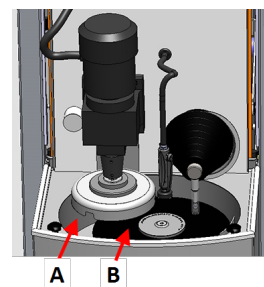

- A** Bowl
- B** Grinding stone

10. If needed, use the flushing gun to clean the bowl. Press the **Flush** button to start the pump. Place the flushing gun in the holder after use.
11. Remount the stone guard.
12. Tighten the two finger screws.



7.4 Monthly

Recirculation unit

See the manual supplied with the specific equipment.

- Clean the recirculation unit.
- Replace the coolant at least once a month.



Note

Replace the cooling fluid immediately if you notice that it is infected by algae or bacteria.

7.4.1 Cleaning the recirculation unit

1. Clean the recirculation tank and the connected tubes thoroughly.
2. If you use a soap solution to clean the bowl or the recirculation tank, rinse with clean water before filling the recirculation tank.



Note

If the cooling fluid is contaminated by algae or bacteria, replace the cooling fluid immediately.

3. If the cooling water has been infected with bacteria or algae, clean the tank and tubes with a suitable antibacterial disinfectant.
4. Clean the static filter: Remove it and rinse it with water.

7.4.2 Changing the cooling fluid



Note

The coolant contains additive and grinding residue and you must not dispose of it into the waste water drain.
Coolant must be disposed of in compliance with local safety regulations.

Empty the recirculation tank

1. Remove the recirculation tank from the compartment under the machine.
2. Disconnect the water inlet hose from the pump and connect the extra piece of hose (supplied).
3. Place the other end of the hose in a container of a suitable size.
4. From the **Maintenance** menu select **Empty recirculation tank**.
5. Press **F1** to start the pump.



6. The pump stops automatically. To stop it manually, press **Stop**



7. Follow the on-screen instructions.



CAUTION

Avoid skin contact with the coolant additive.

7.5 Annually

Inspect the safety cover



Hint

If the machine is used for more than one 7-hour shift per day, carry out inspection more often.

1. Visually inspect the safety cover for signs of wear or damage such as cracks, dents, or damage to the sealing edge.

Replacing the safety cover screen



Note

The safety cover screen must be replaced immediately if it has been weakened by collision with projectile objects or if there are visible signs of deterioration or damage.



Note

The screen must be replaced to remain compliant with the safety requirements stated in EN 16089.

To ensure its intended safety, the safety cover screen must be replaced every 5 years. A label on the screen indicates when it must be replaced.

Struers
Safety glass
Sicherheitsglas
Verre sécurit



Recirculation unit

See the manual supplied with the specific equipment.

7.5.1 Test the safety devices

The safety devices must be tested at least once a year.



WARNING

Do not use the machine with defective safety devices.
Contact Struers Service.



Note

Testing should always be performed by a qualified technician
(electromechanical, electronic, mechanical, pneumatic, etc.).

See

- [Emergency stop ▶ 41](#)
- [Safety cover ▶ 42](#)

7.5.2 Emergency stop

Test 1



1. Press the Start button. The machine starts operating.



2. Press the emergency stop.



3. If operation does not stop, press the Stop button.
4. Contact Struers Service.

Test 2

1. Press the emergency stop.



2. Press the Start button.



3. If the machine starts, press the Stop button.



4. Contact Struers Service.

7.5.3 Safety cover

The cover has a safety switch system to prevent the operator from coming into contact with the moving parts of the working zone while the cover is open.

A locking mechanism prevents the operator from opening the cover until the grinding disc stops rotating.

The cover also acts as a shield to guard the operator in case of hazardous projectiles such as specimens which are not properly secured.

Test 3

1. Open the protective cover.
2. Press the Start button.



3. If the machine starts, press the Stop button.



4. Contact Struers Service.

7.6 Spare parts

For specific safety related parts, see the section "Safety Related Parts of the Control System (SRP/CS)" in the section "Technical data" in this manual.

Technical questions and spare parts

If you have technical questions or when you order spare parts, state the serial number and the year of production. This information is stated in the name plate on the machine.

For further information, or to check the availability of spare parts, contact Struers Service. Contact information is available on [Struers.com](https://www.struers.com).

7.7 Service and repair

We recommend that a regular service check be carried out yearly or after every 1500 hours of use.

When the machine is started up, the display shows information about total operation time and the machines service information.

After 1500 hours of operation time, the display will show a message reminding the user that a service check should be scheduled.



Note

Service must only be performed by a qualified technician (electromechanical, electronic, mechanical, pneumatic, etc.). Contact Struers Service.

7.7.1 Service of air system



CAUTION

Proceed carefully when servicing the air system. See Air diagram 16292002 in [Diagrams ▶ 55](#)

1. Rest pressure (up to 6 bar) inside air cylinder CY1 after the main air supply is disconnected and bled.
2. To bleed CY1 - add 3-6 bar pressure shortly to the Y5 pilot port.
3. Close the safety cover before bleeding and adding compressed air.
4. Bleeding will make the specimen mover head move down if not supported.
5. Adding pressure to the machine after bleeding will move the sample mover head uncontrolled upwards.

7.8 Disposal



Equipment marked with a WEEE symbol contains electrical and electronic components and must not be disposed of as general waste.

Contact your local authorities for information on the correct method of disposal in accordance with national legislation.

For disposal of consumables and recirculation fluid, follow local regulations.

8 Troubleshooting - AbraPlan-30

Error	Cause	Action
Display text is not clear.	The display is sensitive to temperature changes.	Change the brightness in the Configuration menu.
Water is not draining away.	Drain hose squeezed.	Straighten the hose.
	Drain hose clogged.	Clean the hose.
	Drain hose does not slope downwards.	Adjust the hose to an even slope.
Continuous, irregular wear on a grinding surface.	Coupling on the specimen holder/mover plate or the specimen mover head is worn.	Replace the coupling. Contact Struers Service.
Water leakage.	A leak in the cooling unit water hose.	Check the hose for leakages and tighten the hose clamp.
Specimens, cooling unit or equipment is corroded.	Not enough additive for cooling fluid.	Add Struers cooling fluid additive to the cooling fluid. Use the correct concentration. Use a refractometer to check. See the Maintenance section.
No material is removed.	The grinding stone/diamond grinding disc is covered with material.	Dress the grinding stone/diamond grinding disc.
	Insufficient cooling fluid.	Fill up the recirculation unit tank.
	Insufficient grinding force.	Adjust the grinding force.
The specimen heats up.	Insufficient cooling fluid.	Fill up the recirculation unit tank.
	Cooling unit pump is blocked.	Clean the pump and the cooling unit.

Error	Cause	Action
Specimens are not plane.	The grinding stone/diamond grinding disc is covered with material.	Dress the grinding stone/diamond grinding disc. Select Removal-Time as grinding mode.
	The specimen holder is not balanced. or Too few specimens in the specimen holder. or Badly centered large specimen or specimen with too small a distribution in one direction.	Balance the holder. For instance, use one or more blank specimens to balance the holder.
A squeaking noise is heard.	The V-belt slides.	Contact Struers Service.
A hissing noise is heard when the machine is operating and is switched off.	There is a leak in the air system.	Tighten the fittings and replace defective air tubes, if needed.
There are violent vibrations when the machine is operating.	The grinding stone is defective and out-of-balance.	Replace the stone.
	The specimen holder is not balanced. There are too few specimens in the specimen holder. Or Large specimens are badly centred or there are specimens with too small a distribution in one direction.	Balance the holder. For instance, use one or more blank specimens to balance the holder.
The machine is very noisy when idling.	The axial bearing is defective.	Contact Struers Service.
	The spindle or motor bearings are defective.	Contact Struers Service.

8.1 Messages and errors - AbraPlan-30

Error messages are divided into two classes:

- Messages and errors

8.1.1 Messages

Messages provide information about the machine's status and minor errors.

8.1.2 Errors

Errors must be corrected before operation can be continued.

Press **Enter** to acknowledge the error/message.

#	Error message	Cause	Action
7	Action not allowed by operation mode.	Operation mode does not allow editing.	Change operation mode to a higher level, eg. Configuration .
54	The process is paused. This might affect removal accuracy. For the greatest accuracy start a new process.	When the process is paused a new reference point will be calculated for the remaining removal, and this will affect the overall accuracy of the desired removal.	Press OK to continue. Press Stop to cancel the process.
101	Warning Cannot keep preset force.	The machine could not maintain the selected force.	Make sure that the air pressure is 6 bar. Re-start the process. If the error remains, contact Struers Service.
114	Warning Disc motor: Warning: General. Warning code: 0	Non-specific warning reported by movement unit.	Re-start. If the error remains, contact Struers Service. Make a note of the reason code displayed.
141	Warning No air connected or air pressure too low.	The air supply is not connected or the pressure is too low.	Check the air supply connection. Make sure that the air pressure is min. 6 bar.
151	Warning Beacon not detected! Either check beacon connection or disable it in Options menu.		If no beacon is installed, disable the beacon in the Options menu. If a beacon is installed: check the connection. Re-start. If the error remains, contact Struers Service..

#	Error message	Cause	Action
155	Warning Signal from dresser vibration detector is out of range! Surface search procedure might not be precise.	Possible causes: <ul style="list-style-type: none"> heavy vibrations from the surroundings a fault in the sensor or its mounting 	Make sure that there are no external sources of vibration close to the machine. Re-start. If the error remains, contact Struers Service.
45	Error Disc motor: Positioning error. Check for obstructions.	The dresser arm could not move as requested.	Make sure that nothing obstructs the movement of the dresser arm.
46	Error The head did not move down sufficiently for the calibration to start. Calibration aborted.	This message is shown during calibration. The specimen mover head tries to move down to generate force. If it cannot move down enough this error is shown.	Make sure that nothing obstructs the movement of the specimen mover head.
50	Error Disc motor: The motor is too hot and has been stopped. Allow motor to cool before starting a process.	The load of the motor has made the motor too hot to continue with the process.	Let the motor cool off for 10 minutes. Re-start.
73	Error Disc motor: SMU is offline. Call a Service Technician.	Communication with the stepper motor unit is lost.	Re-start. If the error remains, contact Struers Service.
80	Error The mover head did not move correctly. - Check the air supply. - Check for any obstructions.	Something has prevented the specimen mover head tried from moving.	Check the air supply. Make sure that nothing obstructs the movement of the specimen mover head.
91	Error Dresser reference search, sweep sensor not deactivated.		Re-start. If the error remains, contact Struers Service.

#	Error message	Cause	Action
92	Error Dresser reference search, sweep sensor not activated.	The dresser sweep reference position cannot be found.	Re-start. If the error remains, contact Struers Service.
97	Error Dresser reference search, feed sensor not deactivated.		Re-start. If the error remains, contact Struers Service.
98	Error Dresser reference search, feed sensor not activated.	The dresser feed reference position cannot be found.	Re-start. If the error remains, contact Struers Service.
99	Error Disc motor: Movement is blocked.	Motor and/or movement is blocked.	Make sure that nothing obstructs the movement.
100	Error Disc motor: Error: General. Error code: 0 Try to restart the machine	Non-specific error reported by movement unit.	Re-start. If the error remains, contact Struers Service. Make a note of the error code displayed.
103	Error The required air pressure is not obtained. - Check the air supply.		Make sure that the air pressure is min. 6 bar. Re-start. If the error remains, contact Struers Service.
106	Error Dresser movement error during searching.	The dresser could not complete the reference search movement.	Re-start. If the error remains, contact Struers Service.
107	Error Stone centre washer not found during searching.	The dresser must detect the stone centre washer as a part of the surface search.	Re-start. If the error remains, contact Struers Service.

#	Error message	Cause	Action
161	Error Disc motor: Frequency inverter temperature alarm. Reason code: 0x0	The load on the frequency inverter which drives the disc motor has caused a temperature alarm.	Reduce the load.
29	Fatal error Emergency stop mode active, but monitoring switch released.	The emergency stop button has been activated, but the internal monitoring switch is not active.	This error can appear if the emergency stop button is released very slowly (i.e. more than several seconds). Re-start. If the error remains, contact Struers Service.
44	Fatal error Disc motor: Communication error. Call a Service Technician.	Communication with the disc motor frequency inverter has been lost.	Re-start. If the error remains, contact Struers Service.
61	Fatal error Machine failed during Power On Self Testing. Try restarting the machine. Contact Struers technical support if the problem persists. Reason: #__ - Unknown error		Re-start. If the error remains, contact Struers Service. Make a note of the reason code.
62	Fatal error The cover open signal is present while the lock is locked. Call a Service Technician.		Make sure that the cover is completely closed. Re-start. If the error remains, contact Struers Service.
77	Fatal error Emergency stop released, but monitoring switch still on. Call a Service Technician.		Re-start. If the error remains, contact Struers Service.

9 Technical data

9.1 Technical data

	Catalog No:	06296129, 06296146
Disc	Diameter	356 mm (14")
	Speed	1450 rpm
	Rotational direction	Counter-clockwise
	Motor power	–
	- Continuous (S1)	4.0 kW (5.4 hp)
	- Maximum (S3)	N/A
Specimen mover head	Individual specimen	–
	- Force	-
	- Specimen height	-
	Specimen holder	–
	- Diameter	Max. 200 mm
	- Force	50 - 700 N (10 - 150 lbf)
	Rotational speed	170 rpm
	Rotational direction	Counter-clockwise
	Motor	0.37 kW (0.5 hp)
	Torque	17 Nm
Features	Material removal sensor (built-in)	–
Options	Automatic dosing, up to 7 pumps	N/A
	Transparent cover	Standard
	Safety cover	Standard
	Beacon	06296900
	Recirculation cooling system	06296929, 06296946, 06296954

Software and electronics	Controls	Touch pad, Turn/push knob
	Display	LCD, TFT-color 5.7", 320 x 240 dots with LED back light
Safety standards		CE-labeled according to EU directives
REACH		For information about REACH, contact your local Struers office.
Operating environment	Surrounding temperature	5-40°C (41-104°F)
	Humidity	< 85 % RH non-condensing
Power supply	Voltage/frequency	3 x 200-240 V (50-60Hz), 3 x 380-480 V (50-60Hz)
	Power inlet	3 phase (3L + PE)
	Power, nominal load	4.5 kW
	Power, idle	N/A
	Current, nominal load	15.4 A , 9.1 A
	Current, max.	30 A , 20.5 A
Cooling pump	Pressure	1 - 4 bar (14.5-58 psi)
	Minimum flow	4.5 L/min
Air supply	Pressure, compressed air	6 - 9.9 bar (87-145 psi)
	Air flow/consumption	30 L/min (8 gpm)
	Air quality	The air supplied must be of Class 6.8.4. or better, as specified in ISO 8573-1
Exhaust	Recommended capacity	50 m ³ /h (1750 ft ³ /h)
Safety Circuit Categories/Performance Level	Emergency stop	PL c, Category 1 Stop category 0
	Work zone interlock	PL b, Category b Stop category 0
	Work zone interlock locking	PL a
Residual Current Circuit Breaker (RCCB)		Type B, 30 mA (or better) is required

Noise level	A-weighted sound emission pressure level at workstations	LpA = 64.6 dB(A) (measured value). Uncertainty K = 4 dB
Vibration level	Declared vibration emission	Total vibration exposure to upper parts of the body does not exceed 2.5 m/s ²
Dimensions and weight (without cover)	Width	N/A
	Depth	N/A
	Height	N/A
	Weight	N/A
Dimensions and weight (with cover/safety cover)	Width	847 mm
	Depth	990 mm
	Height - cover closed/cover open	1565/1875 mm
	Weight	400 kg (882 lbs)

9.2 Safety Circuit Categories/Performance Level



Note
The performance level is based on this machine being in operation 8 hours per day.

Safety Circuit Categories/Performance Level	
Work zone interlock	EN 60204-1, Stop category 0 EN ISO 13849-1, Category b Performance Level (PL) b
Work zone interlock locking	EN ISO 13849-1, PL a
Emergency stop	EN 60204-1, Stop category 0 EN ISO 13849-1, Category 1 Performance Level (PL) c

9.3 Noise and vibration levels

Noise level	A-weighted sound emission pressure level at workstations	$L_{pA} = 64.6 \text{ dB(A)}$ (measured value) Uncertainty $K = 4 \text{ dB}$ Measurements made in accordance with EN ISO 11202
<p>Noise level: The figures quoted are emission levels and are not necessarily safe working levels. While there is a correlation between the emission and exposure levels, this cannot be used reliably to determine whether or not further precautions are required. Factors that influence the actual level of exposure of the workforce include characteristics of the work room, the other sources of noise, etc., i.e. the number of machines and other adjacent processes. Also, the permissible exposure level can vary from country to country. This information, however, will enable the user of the machine to make a better evaluation of the hazard and risk.</p>		

Vibration level	During preparation	N/A
------------------------	--------------------	-----

9.4 Safety Related Parts of the Control System (SRP/CS)



WARNING

Safety critical components must be replaced after a maximum lifetime of 20 years.
Contact Struers Service.



Note

SRP/CS (safety-related parts of a control system) are parts that have an influence on safe operation of the machine.



Note

Replacement of safety critical components must only be performed by a Struers engineer or a qualified technician (electromechanical, electronic, mechanical, pneumatic, etc.).
Safety critical components must only be replaced by components with at least the same safety level.
Contact Struers Service.

Safety related part	Manufacturer/Manufacturer description	Manufacturer catalog no.	Electrical ref.	Struers catalog no.
Emergency stop button	Schlegel Latching mushroom head	ES Ø22 type RV	S1	2SA10400
Emergency stop contact	Schlegel Contact block	MTO, 1 NC	S1	2SB10071
Emergency stop, Module holder	Schlegel Module holder, 3 elements	MHL	S1	2SA41603
Main safety cover interlock with locking device	Schmersal Solenoid interlock	AZM 170SK-11/02ZRK-2197 24 V AC/V DC	YS1	2SS00025
Work zone interlock locking sensor	Schmersal Safety sensor/BNS 120-02Z	101178078	SS1	2SS00130
Safety relay	Omron Safety relay unit	G9SB-3012-A	KS1	2KS10006
Safe Limited Speed relay	Reer Safety speed monitor	SV-MR0	KS2	2KS10034
Tacho sensors	Schneider Electric Cylindrical proximity sensor	E2A-S08KS02-WP-B1 2M	HQ4/HQ5	2HQ00070
Contactors, cooling water	Omron Motor contactor	J7KNG-10-10-24D	K1	2KM71410
Frequency inverter, stone motor	Lenze Frequency inverter i550	200 V: i55AE255D1AV10001 S	A5	2PU52550
		400 V: I55AE255F1AV10001 S	A5	2PU54550

Safety related part	Manufacturer/Manufacturer description	Manufacturer catalog no.	Electrical ref.	Struers catalog no.
Frequency inverter, Specimen mover	Lenze Frequency inverter i550	200 V: i55AE175D1AV10001 S	A4	2PU52075
		400 V: i55AE175F1AV10001S	A4	2PU54075

9.5 Diagrams

Title	No.
AbraPlan-30, Block diagram	16293053 C
AbraPlan-30, Water diagram	16292005 B
AbraPlan-30, Air diagram	16292002 C

16293053 C

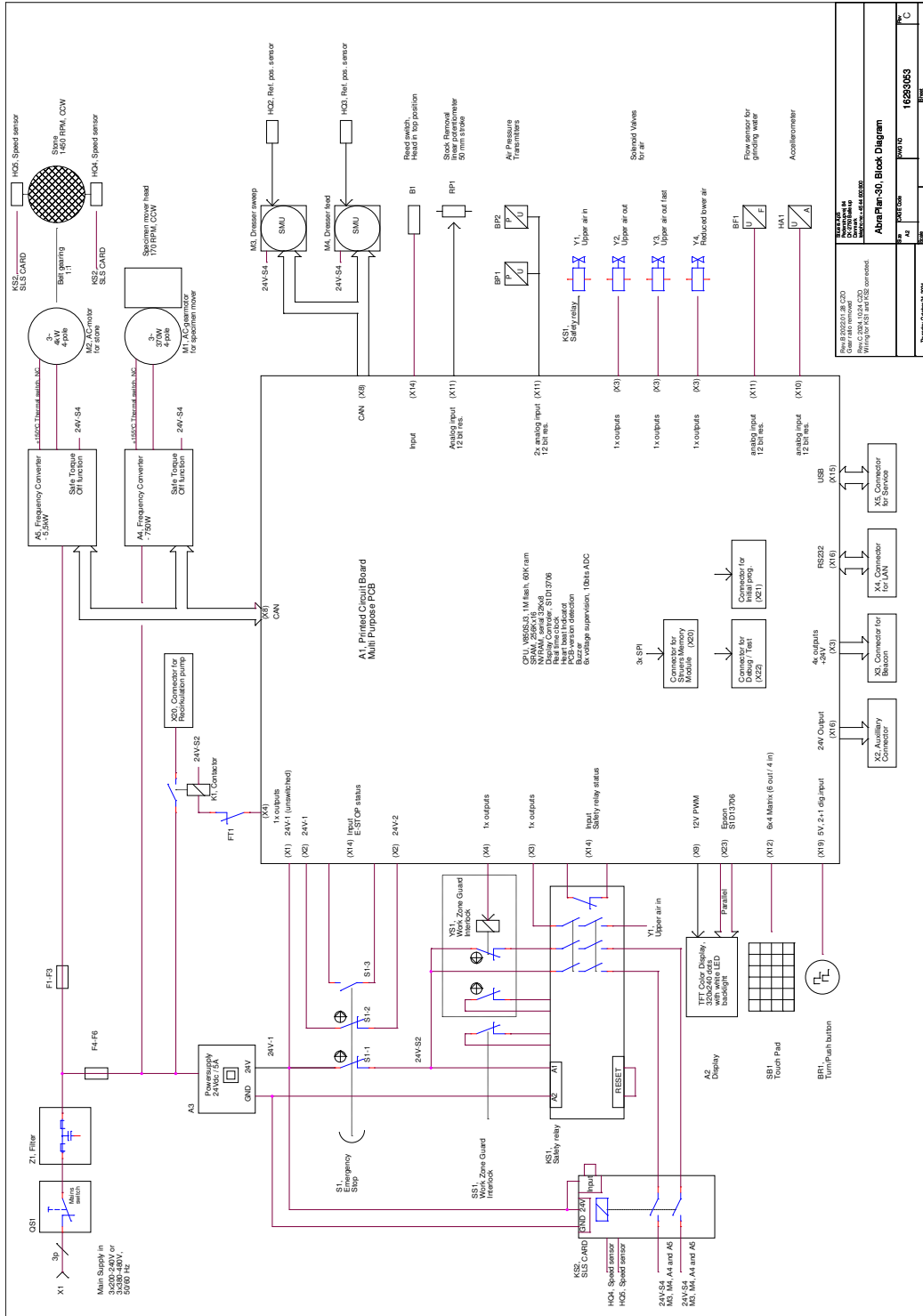

AbraPlan-30 Block Diagram	16293053
Revision: 02/2014, 16293053	16293053
Warning: All RS232 connections must be made to the correct pins.	
Thomas Grottel, 16293053	

16292005 B

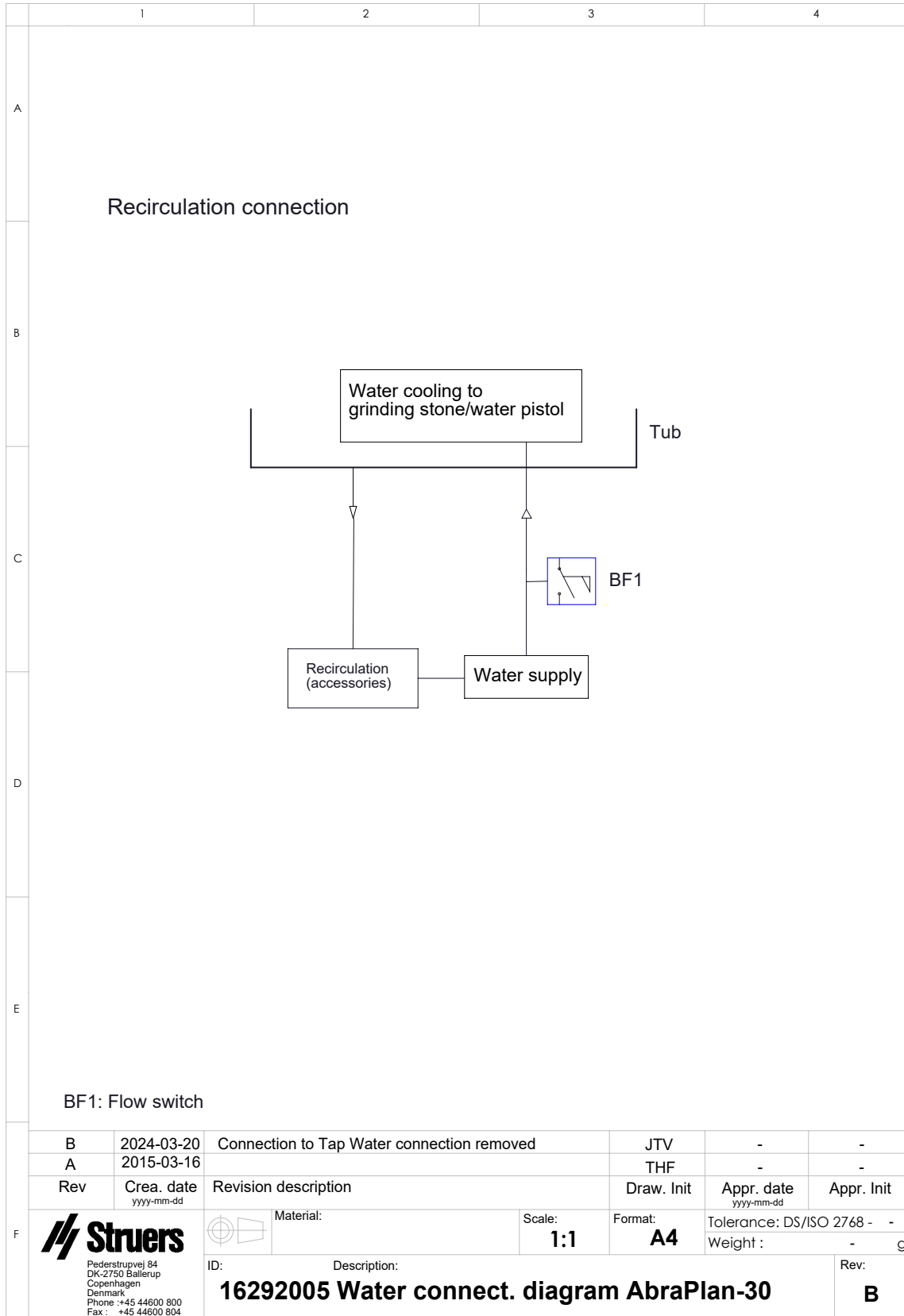

9.6 Legal and regulatory information

FCC notice

This equipment has been tested and found to comply with the limits for a Class B digital device, pursuant to part 15 of the FCC Rules. These limits are designed to provide reasonable protection against harmful interference in a residential installation. This equipment generates, uses and can radiate radio frequency energy and, if not installed and used in accordance with the instructions, may cause harmful interference to radio communications. However, there is no guarantee that interference will not occur in a particular installation. If this equipment does cause harmful interference to radio or television reception, which can be determined by turning the equipment off and on, the user is encouraged to try to correct the interference by one or more of the following measures:

- Reorient or relocate the receiving antenna.
- Increase the separation between the equipment and receiver.
- Connect the equipment into an outlet on a circuit different from that to which the receiver is connected.

10 Manufacturer

Struers ApS
Pederstrupvej 84
DK-2750 Ballerup, Denmark
Telephone: +45 44 600 800
Fax: +45 44 600 801
www.struers.com

Responsibility of the manufacturer

The following restrictions should be observed, as violation of the restrictions may cause cancellation of Struers legal obligations.

The manufacturer assumes no responsibility for errors in the text and/or illustrations in this manual. The information in this manual is subject to change without notice. The manual may mention accessories or parts not included in the supplied version of the equipment.

The manufacturer is to be considered responsible for effects on safety, reliability, and performance of the equipment only if the equipment is used, serviced, and maintained in accordance with the instructions for use.

Declaration of Conformity

Manufacturer	Struers ApS • Pederstrupvej 84 • DK-2750 Ballerup • Denmark
Name	AbraPlan-30
Model	N/A
Function	Plane grinding machine
Type	0629
Cat. no.	06296129 06296146
Serial no.	



Module H, according to global approach



We declare that the product mentioned is in conformity with the following legislation, directives and standards:

2006/42/EC	EN ISO 12100:2010, EN ISO 13849-1:2015, EN ISO 13849-2:2012, EN ISO 13850:2015, EN ISO 16089:2015, EN 60204-1:2018, EN 60204-1-2018/Corr.:2020
2011/65/EU	EN 63000:2018
2014/30/EU	EN 61000-6-2:2005, EN 61000-6-2:2005/Corr.:2005, EN 61000-6-4:2007, EN 61000-6-4-A1:2011
Additional standards	NFPA 79, FCC 47 CFR Part 15 Subpart B

Authorized to compile technical file/
Authorized signatory

VP Operations

Date: [Release date]

en For translations see
bg За преводи вижте
cs Překlady viz
da Se oversættelser på
de Übersetzungen finden Sie unter
el Για μεταφράσεις, ανατρέξτε στη διεύθυνση
es Para ver las traducciones consulte
et Tõlked leiate aadressilt
fi Katso käännökset osoitteesta
fr Pour les traductions, voir
hr Za prijevode idite na
hu A fordítások itt érhetők el
it Per le traduzioni consultare
ja 翻訳については、
lt Vertimai patalpinti
lv Tulkojumus skatīt
nl Voor vertalingen zie
no For oversættelser se
pl Aby znaleźć tłumaczenia, sprawdź
pt Consulte as traduções disponíveis em
ro Pentru traduceri, consultați
se För översättningar besök
sk Preklady sú dostupné na stránke
sl Za prevode si oglejte
tr Çeviriler için bkz
zh 翻译见

www.struers.com/Library