

DuraVersa-100

Instruction Manual

Original Instructions



CE

Doc. no.: 16617026_A_en
Date of release: 2024.09.11

Copyright

The contents of this manual are the property of Struers ApS. Reproduction of any part of this manual without the written permission of Struers ApS is not allowed.

All rights reserved. © Struers ApS.

Table of Contents

1 About this manual	5
1.1 Accessories and consumables	5
2 Safety	5
2.1 Intended use	5
2.2 DuraVersa-100 safety precautions	6
2.2.1 Read carefully before use	6
2.3 Safety messages	7
2.4 Safety messages in this manual	8
2.5 Fixed guards	10
3 Get started	10
3.1 Device description	10
3.2 Overview	11
4 Transport and storage	12
4.1 Transport	12
4.2 Long-term storage or shipping	13
5 Installation	14
5.1 Installation requirements	14
5.2 Dimensions	15
5.3 Unpack the machine	15
5.4 Check the packing list	16
5.5 Location	17
5.6 Lift the machine	19
5.7 Place the machine	21
5.7.1 Level the machine	21
5.7.2 Remove the transport safety plate	21
5.8 Install the monitor	22
5.9 Power supply	22
5.9.1 Connection to the machine	23
5.10 Indenters	24
5.11 Mount an XY-stage, anvil or table	25
5.12 Noise	26
5.13 Vibration	27
6 Operate the machine	27
6.1 The software	28

6.2	Start the machine	28
6.3	Emergency stop activated	28
6.4	Perform a basic test	29
7	Maintenance and service	31
7.1	General cleaning	31
7.2	Daily	32
7.3	Weekly	32
7.3.1	Monitor	32
7.3.2	Weekly inspection	32
7.4	Annually	33
7.4.1	Spindle	33
7.4.2	Test the safety devices	33
7.4.3	Emergency stop	34
7.4.4	Calibration	34
7.5	Service and repair	34
7.5.1	Spare parts	35
7.5.2	Replace the fuse	35
7.6	Disposal	36
8	Troubleshooting	36
8.1	Troubleshooting	36
8.2	Messages and errors	38
9	Technical data	42
9.1	Technical data	42
9.2	Safety Related Parts of the Control System (SRP/CS)	46
9.3	Diagrams - DuraVersa-100	46
10	Manufacturer	49
	Declaration of Conformity	51

1 About this manual

**CAUTION**

Struers equipment must only be used in connection with and as described in the Instruction Manual supplied with the equipment.

**Note**

Read the Instruction Manual carefully before use.

**Note**

If you want to view specific information in detail, see the online version of this manual.

1.1 Accessories and consumables

Accessories

For information about the available range, see the DuraVersa-100 brochure:

- [The Struers Website](http://www.struers.com) (<http://www.struers.com>)

Consumables

The machine is designed to be used only with Struers consumables specifically designed for this purpose and this type of machine.

Other products may contain aggressive solvents, which dissolve e.g. rubber seals. The warranty may not cover damaged machine parts (e.g. seals and tubes), where the damage can be directly related to the use of consumables not supplied by Struers.

For information about the available range, see: [The Struers Website](http://www.struers.com) (<http://www.struers.com>).

2 Safety

2.1 Intended use

Samples are secured on a fixed anvil or optional XY-stage.

The machine is to be used in a professional working environment (e.g. a materialographic laboratory **or industrial setting**). The machine is intended to be used by adult, qualified personnel.

The machine may only be operated as described in this manual. The manufacturer is not liable for the damage caused by improper use.

Only use the machine when it is technically in good working order and use it according to the intended use, paying attention to the safety and potential hazards referred to in this manual.

Manufacturer responsibilities expire when:

- Not or insufficiently complying with the information in this manual.
- Using spare parts or parts not approved by the manufacturer.
- The machine is operated incorrectly.
- Removing, manipulating or not using safety features.
- Changing functions of the machine.
- Unauthorized modifications to the machine are applied.
- Maintenance is not carried out according to instructions.
- The machine is used unintentionally.

Model DuraVersa-100 A, B, C

2.2 DuraVersa-100 safety precautions

2.2.1 Read carefully before use

1. Ignoring this information and mishandling of the equipment can lead to severe bodily injuries and material damage.
2. Struers equipment must only be used in connection with and as described in the Instruction Manual supplied with the equipment.
3. The machine must be installed in compliance with local safety regulations. All functions on the machine and any connected equipment must be in working order.
4. Any defects observed must be repaired before using the machine.
5. The operator must read the safety precautions and Instruction Manual, as well as relevant sections of the manuals for any connected equipment and accessories.
6. This machine must be operated and maintained only by skilled/trained personnel.
7. The machine must be placed on a safe and stable table with an adequate working height.
8. If two persons work together, make sure they communicate clearly to avoid injuries.
9. Safety devices, such as protective covers/safety switches, must never be removed or bridged during normal use of the machine.
10. If disassembly of safety devices during installation, inspection, maintenance or repair is necessary, the reassembly and inspection of the safety devices must be done immediately after the completion of these activities.
11. When handling oils, greases and other chemical substances, the safety regulations applicable to that product must be observed! Contact with chemicals should be avoided as much as possible. Before working with these materials, the instructions on the package must be read and followed.
12. When handling electric motors, be aware these can get warm during use. Let the motors cool down before you work on them. If this is not possible, appropriate safety measures should be taken, for example the use of gloves.

13. Untrained persons or persons present during a general training, may only perform work under the permanent supervision of a trained operator.
14. All safety and hazard warnings on the machine must always be kept in a legible condition.
15. If the equipment is subjected to misuse, incorrect installation, alteration, neglect, accident or incorrect repair, Struers will accept no responsibility for damage to the user or the equipment.
16. Dismantling of any part of the equipment, during service or repair, should always be performed by a qualified technician (electromechanical, electronic, mechanical, pneumatic, etc.).
17. Hot parts should not come into contact with explosive or highly flammable chemicals.

2.3 Safety messages

Struers uses the following signs to indicate potential hazards.



ELECTRICAL HAZARD

This sign indicates an electrical hazard which, if not avoided, will result in death or serious injury.



DANGER

This sign indicates a hazard with a high level of risk which, if not avoided, will result in death or serious injury.



WARNING

This sign indicates a hazard with a medium level of risk which, if not avoided, could result in death or serious injury.



CRUSHING HAZARD

This sign indicates a crushing hazard which, if not avoided, could result in minor, moderate or serious injury.



HEAT HAZARD

This sign indicates a heat hazard which, if not avoided, can result in minor, moderate or serious injury.



CAUTION



This sign indicates a hazard with a low level of risk which, if not avoided, could result in minor or moderate injury.











Emergency stop

Emergency stop

General messages

-  **Note**
This sign indicates that there is a risk of damage to property, or a need to proceed with special care.
-  **Hint**
This sign indicates that additional information and hints are available.

2.4 Safety messages in this manual

-  **ELECTRICAL HAZARD**
Switch off the electrical power supply before installing electrical equipment.
The machine must be earthed (grounded).
Make sure that the actual electrical power supply voltage corresponds to the voltage stated on the name plate of the machine.
Incorrect voltage can damage the electrical circuit.
-  **ELECTRICAL HAZARD**
Avoid contact of electric live parts with liquids as this can cause short circuits.
-  **WARNING**
Struers equipment must only be used in connection with and as described in the Instruction Manual supplied with the equipment.
-  **WARNING**
Do not use the machine with defective safety devices.
Contact Struers Service.
-  **WARNING**
Before you release the emergency stop, investigate the reason for activating the emergency stop and take any necessary corrective action.
-  **WARNING**
Use only undamaged transportation equipment and tools that are suitable for the load. Cabling must be stored and fixated to prevent hazards and damage during transport. Care and cleanliness are required.
-  **WARNING**
Safety critical components must be replaced after a maximum lifetime of 20 years.
Contact Struers Service.
-  **WARNING**
If two persons work together, make sure they communicate clearly to avoid injuries.

**WARNING**

Any defects observed must be repaired before using the machine.

**WARNING**

Do not remove the fixed guards.
Do not operate the machine without the fixed guards.

**CRUSHING HAZARD**

Take care of your fingers when handling the machine.
Wear safety shoes when handling heavy machinery.

**CRUSHING HAZARD**

Do not place your hand between the specimen and the indenter.

**CRUSHING HAZARD**

Do not hold on to the XY-stage or the anvil while you are using the machine.

**CAUTION**

Laser radiation. Do not stare into beam.
Class 2 laser product.



Laser radiation
CLASS 2
Laser product



**Do not stare
into beam**

**CAUTION**

When carrying or moving the machine, make sure not to hit any objects and the machine does not tilt by 30 degrees or more.

**CAUTION**

When carrying or moving the machine, make sure you do not touch the turret.

**CAUTION**

If the machine is equipped with a motorized XY-stage, remove the transport safety plate before you switch on the machine. If the transport safety plate is not removed, the XY-stage will be damaged.

**CAUTION**

Always switch off the machine if you need to install or remove an XY-stage, otherwise the machine can be damaged.



CAUTION

Prolonged exposure to loud noises may cause permanent damage to a person's hearing.
Use hearing protection if the exposure to noise exceeds the levels set by local regulations.



CAUTION

Before you release the emergency stop, investigate the reason for activating the emergency stop and take any necessary corrective action.

2.5 Fixed guards



WARNING

Do not remove the fixed guards.
Do not operate the machine without the fixed guards.

The fixed guards on drives such as a belt drive, chain drive and gear drive are fitted with fasteners. These safety features prevent contact with these moving parts and therefore protect against severe injuries.

3 Get started

3.1 Device description

The instrument provides a technology base for conducting manual, semi-automatic, or fully automated Micro and Macro Vickers, Knoop, Brinell or Rockwell hardness tests in compliance with applicable ISO and ASTM standards.

It is equipped with a closed-loop load application system, a multi-position tool holder for diamond or ball indenters, and high-quality microscope objectives. A built-in camera evaluates and measures the indentations.

To operate the instrument, the specimen is placed on the anvil/XY-stage, and the desired testing pattern is set up using the testing software. When the test is started, the indenter moves down and applies the selected force to the specimen. For Vickers, Knoop and Brinell following the indentation, the built-in camera performs an optical measurement of the indent. For Rockwell the indentation depth is recorded and calculated into a hardness value. The results can then be stored or exported in various formats.

3.2 Overview

Front view

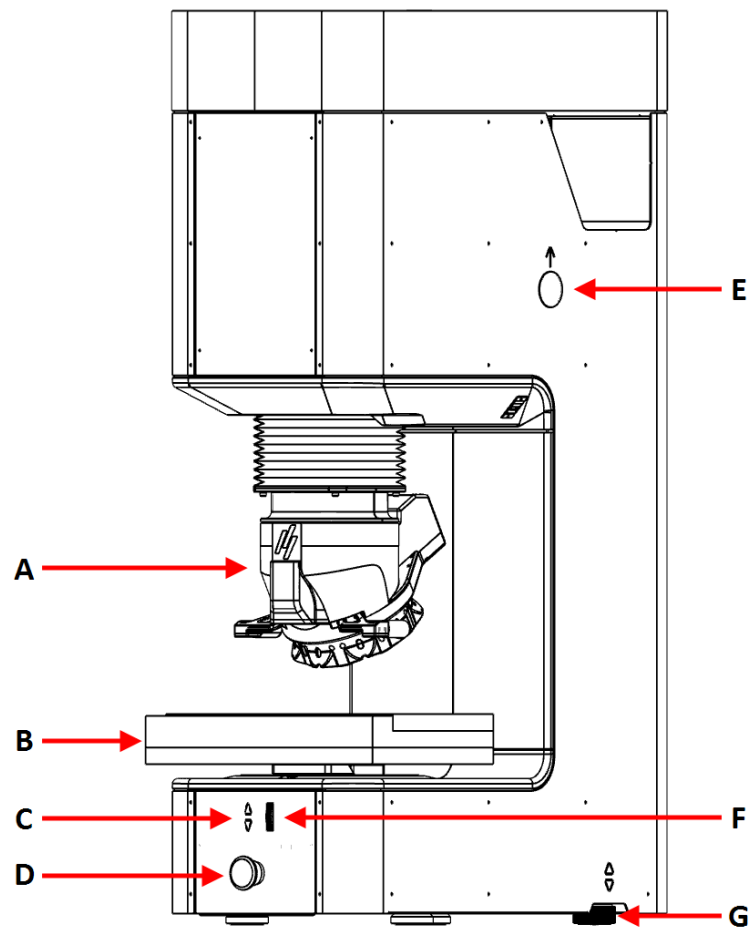

- | | |
|---------------------------------|--------------------------------------|
| A Turret | E Hole for lifting bar |
| B XY-stage | F Scroll wheel for fine focus |
| C Z-axis control buttons | G Vibration damper |
| D Emergency stop | |

Rear view

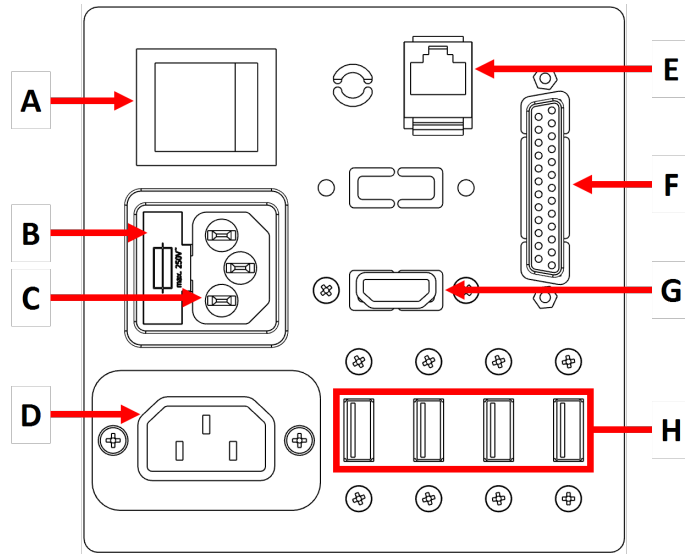

- | | |
|---------------------------------------|-----------------------------------|
| A Main switch | E Ethernet port |
| B Fuse box | F Parallel port (optional) |
| C Electrical power socket | G HDMI port |
| D Power cable adapter, Monitor | H USB ports |

4 Transport and storage

If, at any time after the installation, you have to move the unit or place it in storage, there is a number of guidelines we recommend that you follow.

- Package the unit securely before transportation. Insufficient packaging could cause damage to the unit and will void the warranty. Contact Struers Service.
- We recommend that you use the original packaging and fittings.

4.1 Transport

Note
The machine must always be transported standing upright.

Note
We recommend that you keep all original packaging and fittings for future use.

**Note**

Always use the lifting bar when you transport the machine. Failure to do so could cause severe damage to the load application system of the machine and could void the warranty.

1. Disconnect the unit from the electrical power supply.
2. If an XY-stage is mounted on the machine, fit the transport plate on the XY-stage.
3. Remove the covers covering the lifting bar hole and insert the lifting bar.
4. Place the lifting straps securely around the lifting bar. The straps must be approved for at least twice the weight of the machine.
5. Lift the machine.
6. If needed, package the machine securely before transportation.
7. The machine is ready for transportation.

4.2 Long-term storage or shipping

**Note**

The machine must always be transported standing upright.

**Note**

Always use the lifting bar when you transport the machine. Failure to do so could cause severe damage to the load application system of the machine and could void the warranty.

**Note**

We recommend that you keep all original packaging and fittings for future use.

1. Clean the machine and all accessories thoroughly.
2. Disconnect the unit from the electrical power supply.
3. Prepare the machine for lifting. See [Transport ► 12](#).
4. Remove the feet on the machine.
5. Line up the holes on the transport safety plate with the bolts on the machine. Fasten the machine to the transport safety plate.
6. Place the machine on the pallet.
7. Secure the transport safety plate with bolts and nuts to the pallet.
8. Secure the actuator with a plastic strip.
9. Mount the sides of the crate.
10. Place the accessories box, and other loose items in the crate.
11. To keep the machine dry, place a desiccant (silica gel) in the crate.
12. Mount the lid of the crate.

At the new location

At the new location, make sure that the facilities required are in place. See [Location ► 17](#).

5 Installation

5.1 Installation requirements

- Crane and lifting strap
- Hexagonal wrench, size 13
- Allen key: 3 mm and 5 mm
- Workbench

Required accessories and consumables (ordered separately)

- Test blocks
- Indenters

5.2 Dimensions

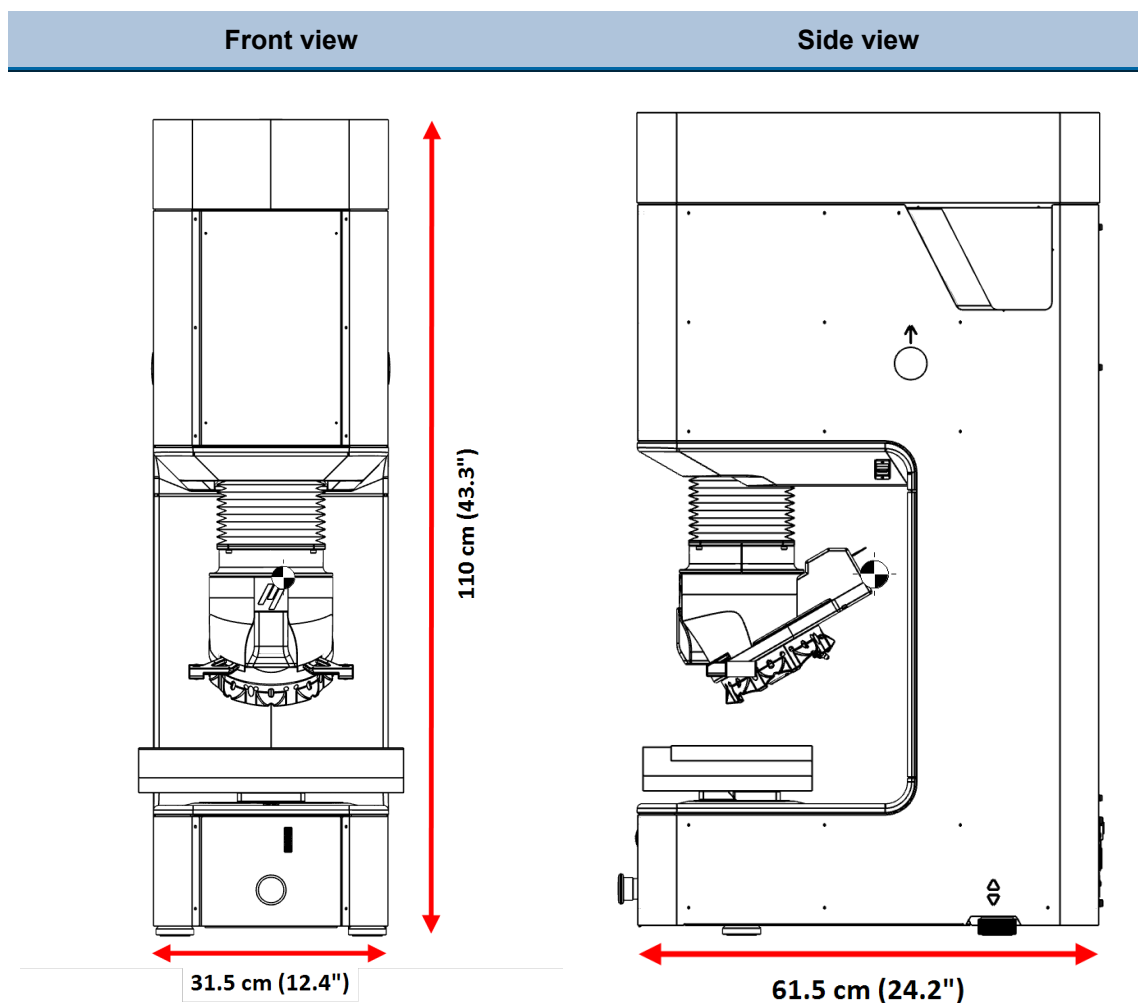

5.3 Unpack the machine

Refer to the DuraVersa-100: How To Unpack instructions delivered with the machine.



Note

Take care while unpacking and handling the machine.

- Do not expose to external impact.
- Do not tilt over 30 degrees.
- Do not touch the turret.

1. Carefully open and remove the top of the packing crate.
2. Remove the sides of the packing crate.
3. Remove the accessory case(s).
4. Carefully lift the foam pieces to access the machine.

**Note**

We recommend that you keep all original packaging and fittings for future use.

5.4 Check the packing list

Some components or parts can be packaged separately and may not be included in the accessories case or may be installed on the machine.

Optional accessories may be included in the packing box.

The packing box contains the following items:

Pcs.	Description
1	DuraVersa-100
1	Accessory case
1	27" monitor (2 x 24" monitors optional)
1	Keyboard (optional)
1	Mouse (optional)
1	Instruction Manual set

Accessory case

Pcs.	Description
	Indenters
	Objective lens
1	Hex key driver 0.9 mm
1	Hex key driver 2.5 mm
1	Wireless keyboard and mouse (optional)
2	Power supply cables
1	Power cable extension
1	USB cable to monitor
1	HDMI cable
2	Spare fuses
1	USB WiFi adapter
1	Bluetooth dongle (optional)

5.5 Location



WARNING

Use only undamaged transportation equipment and tools that are suitable for the load. Cabling must be stored and fixated to prevent hazards and damage during transport. Care and cleanliness are required.



CRUSHING HAZARD

Take care of your fingers when handling the machine. Wear safety shoes when handling heavy machinery.



CAUTION

When carrying or moving the machine, make sure not to hit any objects and the machine does not tilt by 30 degrees or more.



CAUTION

When carrying or moving the machine, make sure you do not touch the turret.

Make sure that the following facilities are available:

- Power supply

The machine must be placed on a safe and stable table with an adequate working height. The table must be able to carry at least the weight of the machine and the accessories.

Recommended workbench dimensions

	60 cm (23.5")
X:	100 cm (40") with monitor and keyboard
Y:	60 cm (23.5")
Z:	70 cm (27.6")

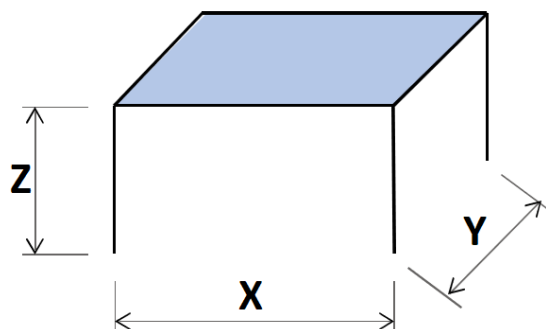

- The machine must be placed close to the electrical power supply.

Space in front of the machine

- Make sure that there is enough room in front of the machine: 100 cm (40").

Space at the rear of the machine

- The machine can be placed against a wall.

- Make sure that there is enough room to access the main switch, USB ports and electrical power connections.
- Make sure that there is enough room at the rear for service access.

Space at the sides of the machine

- Make sure that there is enough room for the monitor (2 monitors if you have chosen this option) and the keyboard: 40 cm (16”).

Vibration

 **Note**
Vibrations can lead to inaccurate measurements and must be avoided.

 **Hint**
A simple way to detect vibrations is to set up a tray of water and watch for ripples on the surface.

- Install the machine in a vibration-free location.
- If possible, install the machine on the ground floor of a building and away from exits or doorways.

Sources of vibration can include:

- Passers-by
- A road with heavy traffic
- Cranes
- Equipment generating vibrations
- Equipment generating sound (acoustic vibration)
- Exposure to wind or air conditioning fans

Illumination

- Make sure that the work station has adequate lighting. Avoid direct glare (dazzling light sources within the operator's line of vision) and reflected glare (reflections of light sources).

A minimum of 300 Lumen is recommended to illuminate the controls and other work areas.

Ambient conditions		
Operating environment	Surrounding temperature	10 - 35°C (50 - 95°F)
	Humidity	10% - 90% RH non-condensing

5.6 Lift the machine



WARNING

Use only undamaged transportation equipment and tools that are suitable for the load. Cabling must be stored and fixated to prevent hazards and damage during transport. Care and cleanliness are required.



CRUSHING HAZARD

Take care of your fingers when handling the machine.
Wear safety shoes when handling heavy machinery.



CAUTION

When carrying or moving the machine, make sure not to hit any objects and the machine does not tilt by 30 degrees or more.
When carrying or moving the machine, make sure you do not touch the turret.

Weight

DuraVersa-100 A / B / C

280 kg (617.3 lbs)

Lifting with a crane



Note

The lifting straps must be approved to lift at least twice the weight of the machine.



Note

Make sure that the crane has a free pathway from the lifting point to the workbench.

To lift the machine from the packing box, use the following lifting tools:

- A crane
- Lifting straps
- A lifting bar. Length: approx. 75 cm (29.5"). Diameter: 25 mm (9.8").



Note

- Do not tilt the packing box more than 30 degrees.
- Be careful not to damage the turret.



Note

Do not place the lifting bar or the lifting straps through the space in the cover of the machine.

Procedure

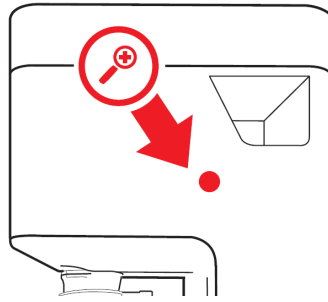

1. Remove the plastic hole covers covering the holes for the lifting bar.

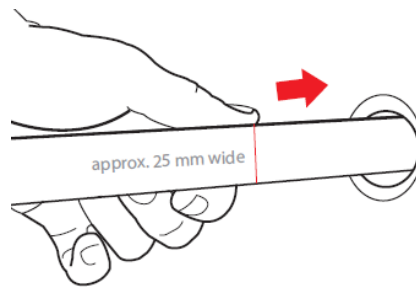

2. Insert the lifting bar.

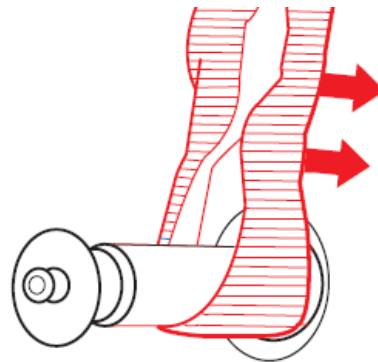

3. Place the lifting straps securely around the lifting bar.
4. Remove the bolts securing the machine to the pallet.
5. Lift the machine out of the packing box.
6. While the machine is lifted, remove the transportation plate.
7. Remove the screws from the bottom of the machine.
8. Mount the four adjustable feet.
9. Make sure that the adjustable feet are of equal height.
10. Lift the machine onto the table.

11. Remove the lifting bar.
12. Remount the plastic hole covers covering the holes for the lifting bar.



Hint
Keep the lifting bar for future use.

5.7 Place the machine

5.7.1 Level the machine

1. Make sure that the 4 adjustable feet are mounted.

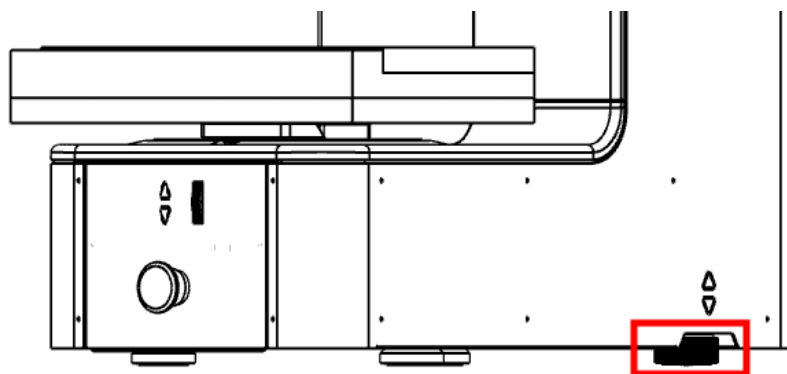

2. Make sure that the anvil or stage is level.
If it is not, adjust the vibration damper in the rear right-hand corner of the machine.

5.7.2 Remove the transport safety plate



CAUTION

If the machine is equipped with a motorized XY-stage, remove the transport safety plate before you switch on the machine. If the transport safety plate is not removed, the XY-stage will be damaged.



Note

The motorized XY-stage moves automatically to perform a reference search on initialization. Damage to the XY-stage will result if the machine is switched on with the transport safety plate mounted.



Hint

We recommend that you keep all original packaging and fittings for future use.

Procedure

 **Note**
This procedure applies to machines equipped with a motorized XY-stage.

Remove the transport safety plate of the XY-stage before you switch on the machine. To do so:

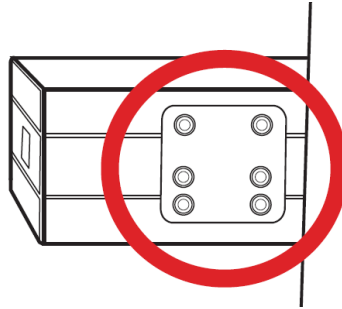

- Unscrew the six screws securing the transport safety plate at the rear. Use a 2.5 mm (0.1") Allen key.

5.8 Install the monitor

 **Note**
You can only connect monitors supplied by Struers to the machine. Failure to adhere to this can result in material damage.

1. Plug the USB cable into the USB port, the HDMI cable to the HDMI port, and the power cable adapter to the power port on the rear of the machine.
2. Make sure that all plugs are connected correctly.

5.9 Power supply

 **ELECTRICAL HAZARD**
Switch off the electrical power supply before installing electrical equipment. The machine must be earthed (grounded). Make sure that the actual electrical power supply voltage corresponds to the voltage stated on the name plate of the machine. Incorrect voltage can damage the electrical circuit.

 **Note**
Local standards can override the recommendations for the main electrical power supply cable. Contact a qualified electrician to verify the solution.

 **Note**
Remove the transport bracket before connecting the machine to the electrical power supply.

**Note**

The equipment is shipped with 2 types of electrical power cables. If the plug supplied on these cables is not approved in your country, the plug must be replaced with an approved plug. If needed, use a C14 IEC320 plug.

The length of the electrical cables supplied is 2.5 m (8.2').

For electrical data, see [Technical data](#) ► 42.

Power socket

The electrical power supply socket must be easy to access.

Single-phase supply*2-pin plug*

The 2-pin plug (European Schuko) is for use on single-phase electrical power connections.

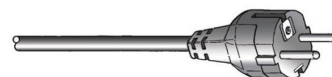

The leads must be connected as follows:

Yellow/Green	Earth (ground)
Brown	Line (live)
Blue	Neutral

3-pin plug

The 3-pin plug (North American NEMA) is for use on single-phase electrical power connections.



The leads must be connected as follows:

Green	Earth (ground)
Black	Line (live)
White	Line (live)

5.9.1 Connection to the machine

1. Connect the electrical power cable to the machine (C14 IEC 320 connector).
2. Connect the cable to the electrical power supply.



Electrical power connection

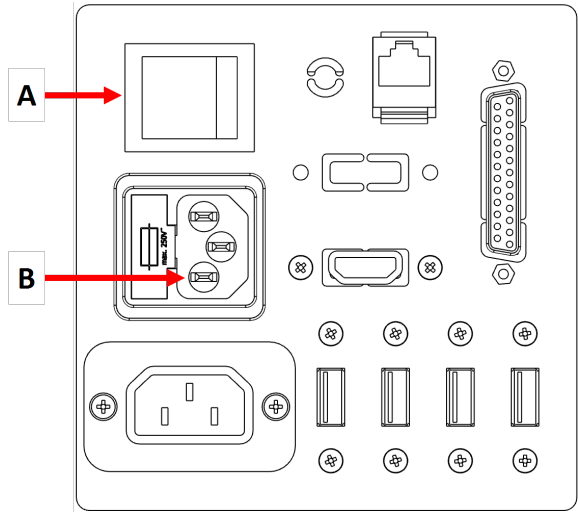



A Main switch

B Electrical power socket

5.10 Indenters

The machine is delivered with preinstalled indenter(s) as ordered.

Mount an indenter

- Note**

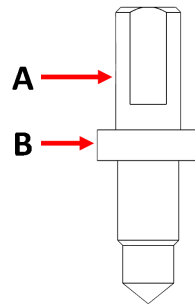
 Make sure that the indenter is intact before you mount it on the machine. A damaged indenter can give invalid results.
- Note**

 Always keep indenters in their case when you are not using them, otherwise they can be damaged.
- Note**

 Only use indenters supplied by Struers.



A Indenter shaft

B Impact

Procedure

1. Raise the head of the machine.
2. Use a soft cloth to wipe any dirt or debris from the indenter.
3. Loosen the fixation screw.
4. Insert the shaft of the new indenter into the indenter holder and push it firmly into place.
5. Tighten the fixation screw.
Do not use excessive force.
6. Install an anvil.
7. Perform a test on a test block to securely seat the indenter.

Check the indenter length

To check the indenter length, see *After mounting an indenter* in the DuraSoft Instruction Manual.

5.11 Mount an XY-stage, anvil or table



CAUTION

Always switch off the machine if you need to install or remove an XY-stage, otherwise the machine can be damaged.



CRUSHING HAZARD

Do not hold on to the XY-stage or the anvil while you are using the machine.



Note

Some accessories may be heavy. Two persons may be required to handle the accessories to avoid damage to the machine.



Note

The XY-stage is usually delivered already mounted on the machine.

 **Note**
The range of force that can be applied is limited when using an XY-stage. Excessive overload can result in irreparable damage to the machine.

Dovetail connector

1. Move the spindle to its top position.
2. Switch off the machine.
3. Use a soft cloth to wipe any dirt or debris from the matte surfaces of the dovetail connection.
4. Carefully slide the stage into the dovetail connection.

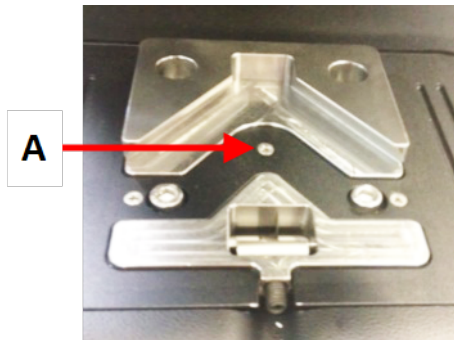

5. Tighten the fixation screw to secure the stage in place. [A]
6. Switch on the machine.
7. Configure the XY-stage in the software. See below.
8. Perform a few hardness tests on a test block to securely seat the stage.

Configure a motorized XY-stage

 **Note**
Make sure that the software is configured correctly when a motorized XY-stage is mounted or removed.

1. In the software, select **System > Settings**.
2. Make sure that the option **XY stage** is enabled.

5.12 Noise

For information on the sound pressure level value, see this section: [Technical data ▶ 42](#)

 **CAUTION**
Prolonged exposure to loud noises may cause permanent damage to a person's hearing. Use hearing protection if the exposure to noise exceeds the levels set by local regulations.

5.13 Vibration

For information on the total vibration exposure to hand and arm, see this section: [Technical data](#) ▶42.

6 Operate the machine



WARNING

If two persons work together, make sure they communicate clearly to avoid injuries.



CRUSHING HAZARD

Do not place your hand between the specimen and the indenter.



CRUSHING HAZARD

Do not hold on to the XY-stage or the anvil while you are using the machine.

Electrical power switch

The electrical power switch is located on the rear of the machine.

The switch is lit when the power is switched on.

Emergency stop



CAUTION

Before you release the emergency stop, investigate the reason for activating the emergency stop and take any necessary corrective action.



Note

Do not use the emergency stop for operational stop of the machine during normal operation.



The emergency stop is located on the front of the machine.

- To activate the emergency stop, press the red emergency stop button.
- To release the emergency stop, turn the red emergency stop button clockwise.



Note

Do not use the emergency stop for operational stop of the machine during normal operation.

Before you release the emergency stop, investigate the reason for activating the emergency stop and take any necessary corrective action.

6.1 The software

The machine is operated through the DuraSoft software. See the DuraSoft Instruction Manual.

6.2 Start the machine



CAUTION

Do not operate the machine during initialization and keep your hands away from motorized parts (e.g. turret, stage and spindle).



Hint

The screens shown in this manual may differ from the actual screens in the software.



Note

Make sure that the emergency stop is not activated during start-up.

1. Switch on the machine on the main switch at the rear of the machine. The software initializes and the progress bar is shown. The software version is shown during start-up.

2. Enter the user name and password. The first time you use the machine, the default is:
 - **Username: Admin** (not case sensitive)
 - **Password: None**
3. Select **OK**.
4. A dialog stating that the machine is going to initialize is shown.
5. Select **OK** to start the initialization.
The XY-stage and turret start moving.

6.3 Emergency stop activated



CAUTION

Before you release the emergency stop, investigate the reason for activating the emergency stop and take any necessary corrective action.

If the emergency stop is activated during start-up



If the emergency stop is activated during start-up, an error message is shown.

1. Turn the emergency stop button to release it.
2. If the emergency stop was activated because of a collision or jam, move the head up or down to clear the jam.
3. Select **OK** in the emergency stop dialog to exit the software.

6.4 Perform a basic test



CAUTION
Laser radiation. Do not stare into beam.
Class 2 laser product.



Laser radiation
CLASS 2
Laser product



**Do not stare
into beam**



Note
The following description covers a basic test. For advanced test options, see the DuraSoft Instruction Manual.

- Make sure that the specimen surface is smooth and even.
 - Make sure that the specimen surface is free from oxide scale, foreign matter and completely free of lubricants.
1. Set up the machine with the required type of test, load, scale and required indenter.
 2. Set the dwell time.
 3. Set the right shape correction, if needed.
 4. Place the specimen on the anvil or XY-stage.
 5. Select an objective.

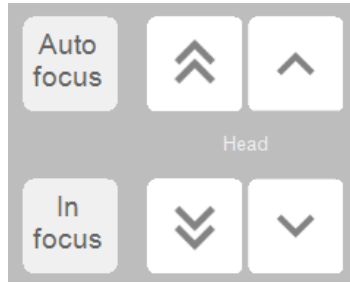

- Use the **Autofocus** button to adjust the focus.
Alternatively, use the **Head** positioning buttons to bring the surface of the specimen into focus manually.
- Select **In focus** to confirm the focus position.



Note
Make sure that the **Z** value is **0.000 mm**. This happens automatically after you use the **Autofocus** function.

- Adjust the light so that the specimen is clearly visible.

Start the test

CRUSHING HAZARD
Do not place your hand between the specimen and the indenter.



- Press **Start** to start the test.



- If you want to cancel the test, press **Stop**.

Note
Do not use the emergency stop to stop the test.

After the indent is made, the software automatically measures the indent and displays the result. The measured hardness value is displayed in the **Test Result** and **Graph** sections.

7 Maintenance and service

Proper maintenance is required to achieve the maximum up-time and operating lifetime of the machine. Maintenance is important in ensuring continued safe operation of your machine.

The maintenance procedures described in this section must be carried out by skilled or trained personnel.

Safety Related Parts of the Control System (SRP/CS)

For specific safety related parts, see the section "Safety Related Parts of the Control System (SRP/CS)" in the section "Technical data" in this manual.

Technical questions and spare parts

If you have technical questions or when you order spare parts, state serial number and voltage/frequency. The serial number and the voltage are stated on the name plate of the machine.

7.1 General cleaning



ELECTRICAL HAZARD

Avoid contact of electric live parts with liquids as this can cause short circuits.



WARNING

Any defects observed must be repaired before using the machine.

To ensure a longer lifetime for your machine, we strongly recommend regular cleaning.



Note

Do not use a dry cloth as the surfaces are not scratch resistant.
Do not use aggressive or abrasive products.



Note

Do not use acetone, benzol or similar solvents.



Note

If needed, use ethanol or isopropanol to remove grease and oil.



Note

Do not use compressed air to clean the machine. Dirt particles can be blown into vital parts (e.g. bearings) and cause malfunctions.

- Clean all accessible surfaces with a soft, damp cloth.

If the machine is not to be used for a longer period of time

- Clean the machine and all accessories thoroughly.

7.2 Daily

- Clean all accessible surfaces with a soft, damp cloth.



Note

If needed, use ethanol or isopropanol to remove grease and oil. Do not use acetone, benzol or similar solvents.

7.3 Weekly



Note

Do not use a dry cloth as the surfaces are not scratch resistant. Do not use aggressive or abrasive products.



Note

Do not use acetone, benzol or similar solvents.



Note

If needed, use ethanol or isopropanol to remove grease and oil.

- Clean the following elements with a soft damp cloth and common household detergents:
 - the front panel
 - the anvil
 - the XY-stage (if installed)
 - painted surfaces

7.3.1 Monitor

Clean the monitor:

1. Wipe the screen using a soft, clean cloth moistened with window cleaner.
2. Use a dry cloth to remove excess moisture.

7.3.2 Weekly inspection

Inspect the following parts before every hardness test or at least every week.

**Hint**

Some of the parts listed may not be included in the configuration of your machine.

Part	Attention	Action	Precaution
Indenter	The tip is dirty.	Wipe the indenter.	Handle the indenter with care.
Eyepiece/Objective/Lens	The lens surface is dirty.	Wipe the lens. Use a special lens cleaning paper.	Do not scratch the objective or lens.
Anvil/XY-stage	Rust.	Remove rust.	Do not bring the stage into contact with the turret.
Test block	Rust.	Replace the test block.	Do not use rusted test blocks.
Spindle cover/Telescopic cover	The cover may be dislocated.	Fasten the cover.	Without the cover there is free access to the spindle.

7.4 Annually

7.4.1 Spindle

**Note**

Do not lubricate the spindle with motor oil.

1. Switch off the machine.
2. Carefully lift the spindle cover.
3. Clean the spindle.
4. Oil the spindle lightly with e.g. a universal household oil.
5. Wipe the spindle thoroughly after lubrication so that as little oil as possible is left on the spindle.
6. Wipe the spindle again after a few days to make sure that no oil residue is left on the spindle surface.

7.4.2 Test the safety devices

The safety devices must be tested at least once a year.

**WARNING**

Do not use the machine with defective safety devices.
Contact Struers Service.

 **Note**
Testing should always be performed by a qualified technician (electromechanical, electronic, mechanical, pneumatic, etc.).

7.4.3 Emergency stop

 **WARNING**
Do not use the machine with defective safety devices.
Contact Struers Service.

Make sure that the emergency stop is functioning correctly:

1. Start the machine.

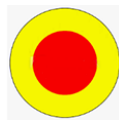

2. Press the emergency stop.



The machine must stop and a message is shown prompting you to release the emergency stop. If this does not happen, contact Struers Service.

3. Release the emergency stop and select **OK** in the **Motor Movement** screen. This will shut down the software.

7.4.4 Calibration

Calibration of both the applicable force and the objectives of the machine require specific equipment. Contact Struers Service to have the load cell or objectives recalibrated.

7.5 Service and repair

We recommend that a regular service check be carried out yearly or after every 1500 hours of use.

 **Note**
Service must only be performed by a qualified technician (electromechanical, electronic, mechanical, pneumatic, etc.).
Contact Struers Service.

Service check

We offer a range of comprehensive maintenance plans to suit the requirements of our customers. This range of services is called ServiceGuard.

The maintenance plans include equipment inspection, replacement of wear parts, adjustments/calibration for optimal operation, and a final functional test.

7.5.1 Spare parts

For specific safety related parts, see the section "Safety Related Parts of the Control System (SRP/CS)" in the section "Technical data" in this manual.

Technical questions and spare parts

If you have technical questions or when you order spare parts, state the serial number and the year of production. This information is stated in the name plate on the machine.

For further information, or to check the availability of spare parts, contact Struers Service. Contact information is available on Struers.com.

7.5.2 Replace the fuse

Fuse dimensions	Fuse rating
5 x 20 mm	3.15 AT, 250 V.

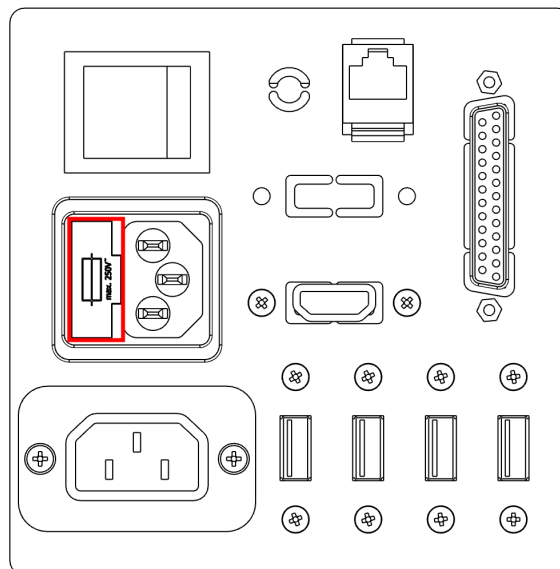

The fuse holder is located directly over the power socket at the rear of the machine.

1. Turn the machine off.
2. Disconnect the power supply cable.
3. Pull out the fuse holder.
4. Remove the blown fuse and replace it with the new fuse.

5. Reinstall the fuse holder.
6. Reconnect the electric power cable.



Hint
Remember to order a new spare fuse.

7.6 Disposal

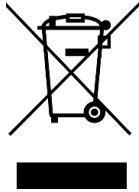

Equipment marked with a WEEE symbol contains electrical and electronic components and must not be disposed of as general waste.

Contact your local authorities for information on the correct method of disposal in accordance with national legislation.

For disposal of consumables and recirculation fluid, follow local regulations.

8 Troubleshooting

8.1 Troubleshooting

You can resolve most minor malfunctions by restarting the machine.

If you experience errors, see the table below for basic troubleshooting. If the error remains, contact Struers Service.

Problem	Action
The Overview camera is lagging/freezing.	<p>If the settings for active image correction have been set to High, the camera cannot process the live video feed.</p> <ol style="list-style-type: none"> 1. Select Visuals > Contrast while the Overview camera is active. 2. Select Default.
The Objective image flickers.	<ul style="list-style-type: none"> • Select Visuals > Contrast, and deselect Automatic.
Most or all buttons are grayed out when the software is started up.	<p>The machine settings file is corrupted due to incorrect shutdown.</p>
The message Force too high is shown when an indenter is started.	<ul style="list-style-type: none"> • Perform an indenter length calibration.

Problem	Action
The message Object detected is shown when an indent is being made	<ol style="list-style-type: none"> 1. Make sure that the specimen is in focus before you start a measurement. 2. If the error remains, calibrate the indenter length.
The message COM port x does not exist is shown.	<p>A digital micrometer connected to the machine has been moved to another USB port.</p> <ol style="list-style-type: none"> 1. Move the connected device back to its original port. 2. Restart the software.
A method is missing in the software. Vickers, Knoop, Brinell, KIC, or HVT cannot be selected in the scale selection dialog.	<ul style="list-style-type: none"> • Make sure that the indenter for the method you are looking for is installed on the turret. • If you want to see the method without the indenter installed, select System > Settings. Make sure that the setting Scales only with indenter is disabled. <p>If the error remains, the method has not been enabled for this machine.</p>
The motorized XY stage stalls during reference search or movements during normal operation.	<ul style="list-style-type: none"> • Make sure that there is nothing obstructing or preventing the stage from moving (transport safety bracket, dirt, etc.)
<p>A Timeout message is shown.</p> <ul style="list-style-type: none"> • Trinamic timeout • Timeout Depthmeter Readout • LCA Timeout 	<ol style="list-style-type: none"> 1. Restart the software. 2. The problem could be caused by the removal of a USB device, or by a faulty USB drive. Use a different USB port for the USB drive or use a different USB drive.
Comet tails or indenter scratches are visible.	<ol style="list-style-type: none"> 1. Make sure that the specimen surface is plane. 2. Clean the indenter. 3. Rotate the indenter 180 degrees to see if the tail/scratch follows the indenter orientation. <ul style="list-style-type: none"> • If it if the tail/scratch follows the indenter orientation,replace the indenter with a new one. • If the tail/scratch does not follows the indenter orientation, contact Struers Service.
There is oil residue on the stage or specimen.	<ul style="list-style-type: none"> • Clean the specimen and the stage.

Problem	Action
Autofocus cannot find the correct focus plane.	<p>If Autofocus settings uses a combination of a high search range and a high search speed, the steps of the autofocus search may be too large to find the actual focus plane.</p> <ul style="list-style-type: none"> Lower the search range and the search speed for the specific objective: Select Visual > Autofocus.
The Vickers or Knoop indents are not symmetrical.	<ol style="list-style-type: none"> Make sure the specimen surface is plane. Make an indent on a test block to verify the asymmetrical indent. <ul style="list-style-type: none"> If the indent on the test block is symmetrical, check that the surface of the specimen is plane. If the indent is asymmetrical, contact Struers Service.
The measurement cursor changes from a green crosshair to a red dot.	<ul style="list-style-type: none"> Use the mouse scroll wheel click function to toggle between the crosshairs and the red dot.
The user interface is shown in Landscape, not Portrait mode.	<ol style="list-style-type: none"> Make sure that the monitor is connected according to the marking on the rear of the hardness tester. Restart the machine.
The touch function on the monitor does not work.	<ol style="list-style-type: none"> Make sure that the USB cable between the monitor and the machine is connected correctly. Press and hold the Menu and the Enter buttons on the side of the monitor to enable or disable the touch function.
Opening the connection to AUX or LCA failed.	<ol style="list-style-type: none"> Restart the software. If the error remains, contact Struers Service.
There is no image on the objective camera.	<ul style="list-style-type: none"> Make sure the objective light level is not set to 0.

8.2 Messages and errors

Errors must be corrected before operation can be continued.



- Press **OK** to acknowledge the error message.
If the error remains, contact Struers Service.

Error message	Explanation	Action
Collision switch active	The turret has hit an object. The spindle is too far up, or the head is too far down.	Make sure that there is no obstacle to the turret movement. Make sure that the spindle is positioned correctly.
DuraSoft-Met was not installed (correctly)	Application could not be found.	Contact Struers Service.
Emergency switch pressed, release switch for further action	Correct the cause of the emergency stop. Release the emergency stop. See Emergency stop activated ► 28 .	If the error remains or if the message occurs without activating the emergency stop, contact Struers Service.
Failed moving to home position	For machines with a load motor. During initialization, the home switch near the load motor has not been activated, and the motor has failed to move to its home position.	Make sure that there is no visible obstruction in the Z-axis. Restart the machine.
Failed moving to safe position	For machines with a motorized head. During initialization, the motorized head failed to retract approx. 1 cm from the current position.	Make sure that there is no visible obstruction in the motorized head.
Failed to find upper limit	For machines with a motorized head. For a special protocol (e.g. the crank shaft), the motorized head must be in the highest position.	If the error remains, contact Struers Service.
Failed to initialize turret	During initialization, the home switch in the turret was not found within the specified time.	Make sure that there is no visible obstruction in the turret.
Failed to initialize XY stage	For machines with a motorized XY stage. During initialization of the XY stage, the limits for the X and Y axes cannot be found.	Make sure there is no visible obstruction. Shut down the machine and reconnect the cable to the XY stage.

Error message	Explanation	Action
Failed to move spindle down	For machines with a motorized head and spindle. During initialization, the spindle failed to move lower .	Make sure that there is no visible obstruction in the motorized head.
Failed to open connection to Com[nr] : Comport name	Communication to the indicated port has failed. The port is present but cannot be opened by the operating system.	Restart the machine.
Force too high!	The measured force is not equal in both loadcells.	Make sure that there is no visible damage on the machine.
Indenter not present	A hardness method is selected which is not suitable for the selected indenter.	Select System > Settings > Scales only with indenter . Alternatively, replace the indenter.
Invalid license key		If you do not have the license key, contact Struers Service.
License expired		Contact Struers Service.
Loadcell not configured	Configuration of the loadcell or loadcells is incorrect.	Restart the machine.
Measurement name is already being used		Use another measurement name.
Missing connection for Com[nr] : Comport name	Communication to the indicated port has failed. The port is present but cannot be opened by the operating system.	Restart the machine.
Motor timeout reading position	Internal communication failure.	Restart the machine.
No data was imported		Import data.
No images loaded!	Chosen file format is not supported.	Use only supported file formats.
No measurements saved	Active image has no measurements.	Perform a measurement.
Object detected	The loadcell detects an unwanted force in the turret. The indenter touches the object on high speed.	Make sure that there is no visible obstruction in the turret. Increase the working distance

Error message	Explanation	Action
Running low on disk space	The D: drive hard disk is running out of disk space.	Carry out file housekeeping and delete redundant files.
System not initialized	The user interface is released by the software before initialization has ended.	Contact Struers Service.
This position cannot be changed	In this case, it is not possible to change the indenter or objective because this is protected by a higher log-in level.	
Timeout depthmeter readout	Internal communication failure between depthmeter and PC.	Restart the machine.
Unsupported scale	You have selected a hardness method scale that is out of range for the selected indenter.	Select System > Settings > Scales only with indenter . Alternatively, replace the indenter.
Unsupported tester	The dongle that is being used is not supported by the software.	Contact Struers Service.
Upper limit not reached	For machines with a motorized head. When the motorized head is in the highest position, but the upper limit has not been activated.	Contact Struers Service.

9 Technical data

9.1 Technical data

Hardness methods	Vickers	ISO 6507 ASTM E384, E92 JIS B 7725
	Knopp	ISO 4545 ASTM E92 JIS Z 2251
	Brinell	ISO 6506 ASTM E10 JIS Z 2243
	Rockwell - optional	ISO 6508 ASTM E18 JIS Z 2245
Conversion		Conversions to other hardness methods according to ASTM E140, ISO 18265, GB/T 1172
Force range	DuraVersa-100A	1.96 - 2452 N (200 gf - 250 kgf)
	DuraVersa-100B	1.96 - 7357.5 N (200 gf - 750 kgf)
	DuraVersa-100C	1.96 - 29430 N (200 gf - 3000 kgf)
Test force	Force application	Load cell, closed loop, force feedback system
	Test force tolerance	< 0.25% for test force 100 gf to 250 kgf < 0.5 % for test forces below 100 gf
	Dwell time settings	Default 10 seconds, user defined. Up to 250 seconds

Electrical data	Power supply DuraVersa-100A/B	100 - 240 V AC, 50 / 60 Hz, single phase
	Power supply DuraVersa-100C	Specify 100 - 110 V AC, 50 / 60 Hz, single phase or 220 - 240 V AC, 50 / 60 Hz, single phase
	Power consumption max. work load	72 W
	Power consumption Idle	60 W
	Power consumption max. load	156 W
Residual Current Circuit Breaker (RCCB)		Type A, 30 mA is required depending on local regulations
Dimensions	Width	31.5 cm (12.4")
	Depth	61.5 cm (24.2")
	Height	110 cm (43.3")
Weight		280 kg (617 lbs)
Read method		Automated from Camera Image
Measurement camera resolution		18 MP
Overview camera resolution		13 MP
Overview camera field of view		variable 40 x 30 mm - 140 x 110 mm (1.6 x 1.2" - 5.5 x 4.3")
Turret	Motorized turret	9 position turret, incl. 1 laser / touch probe, rest freely configurable
Position in nosepiece for overview camera		1
Max no. of indenters		7
Max no. of objectives		7
Indenter Shaft	Diameter	6.35 mm or 3 mm
Available objectives		Selectable 0,7x, 2,5x, 5x, 10x, 20x , 40x 60x and 100x , all long working distance objectives.
Z-Axis		Motorized

Motorized Stage Options	DirectConnect stage, 215 x 160 mm	Travel: 75 x 75 mm Resolution: 0.001 mm Repeatability: ± 0.015 mm Load: up to 400 kgf
	DirectConnect stage, 260 x 205 mm	Travel: 120 x 120 mm Resolution: 0.001 mm Repeatability: ± 0.015 mm Load: up to 400 kgf
	DirectConnect stage, 360 x 205 mm	Travel: 220 x 120 mm Resolution: 0.001 mm Repeatability: ± 0.015 mm Load: up to 400 kgf
	DirectConnect stage, 490 x 224 mm	Travel: 340 x 120 mm Resolution: 0.001 mm Repeatability: ± 0.015 mm Load: up to 4000 kgf
	DirectConnect stage, 410 x 265 mm	Travel: 200 x 150 mm Resolution: 0.001 mm Repeatability: ± 0.015 mm Load: up to 4000 kgf
	DirectConnect stage, 510 x 265 mm	Travel: 300 x 150 mm Resolution: 0.001 mm Repeatability: ± 0.015 mm Load: up to 4000 kgf
	DirectConnect stage, 560 x 265 mm	Travel: 400 x 150 mm Resolution: 0.001 mm Repeatability: ± 0.015 mm Load: up to 4000 kgf
	Auto Illumination	Yes
Stage Illumination	Yes	
Laser/LED Guide with integrated touch probe	Yes	

Software	Operating software	Embedded software for work flow system & tester control
	Integrated PC	Yes
	Monitor	27" touchscreen FHD (2nd monitor optional)
	Dual view	Optional
	Possibility to connect Printer	Yes, but optional (A4, A3 full color laser printer)
	Ethernet Connection	Yes
	Data Export	5 USB ports, RJ45 Ethernet LAN, W-LAN, RS-232, Bluetooth, HDMI
System	Data output	XML, CSV, Certified for Q-DAS (Optional)
Sample height	With motorized stage: 400 kg load capacity	120 mm (4.7")
	With motorized stage: 4000 kg load capacity	100 mm (3.9")
Sample weight	DuraVersa-100A/B	50 kg (110 lbs)
	DuraVersa-100C	200 kg (441 lbs)
Throat depth		230 mm (9.1")
Safety standards		CE labeled according to EU directives
REACH		For information about REACH. contact your local Struers office
Operating environment	Surrounding temperature	10 - 35°C (50 - 95°F)
	Humidity	10 - 90% RH non-condensing
Safety Circuit Categories / Performance Level	Emergency stop	EN ISO 13849-1 PL c, Category 1 Stop category 0
Noise level	A-weighted sound emission pressure level at workstations	< 70 dB(A)
Vibration level	During operation	Total vibration exposure to upper parts of the body does not exceed 2.5 m/s ² .

9.2 Safety Related Parts of the Control System (SRP/CS)



WARNING

Safety critical components must be replaced after a maximum lifetime of 20 years. Contact Struers Service.



Note

SRP/CS (safety-related parts of a control system) are parts that have an influence on safe operation of the machine.



Note

Replacement of safety critical components must only be performed by a Struers engineer or a qualified technician (electromechanical, electronic, mechanical, pneumatic, etc.). Safety critical components must only be replaced by components with at least the same safety level. Contact Struers Service.

Safety Circuit Categories/Performance Level

Emergency stop	EN ISO 13849-1 PL c, Category 1 Stop category 0
-----------------------	--

Safety related part	Manufacturer/Manufacturer description	Manufacturer catalog no.
Emergency stop button	Schneider Electric	XB2BS542C
Emergency stop contact NC	Schneider Electric	ZB2BE102C

9.3 Diagrams - DuraVersa-100

Title	Version
DuraVersa-100A/B, System diagram	1
DuraVersa-100C, System diagram	1

System diagram - DuraVersa-100A/B

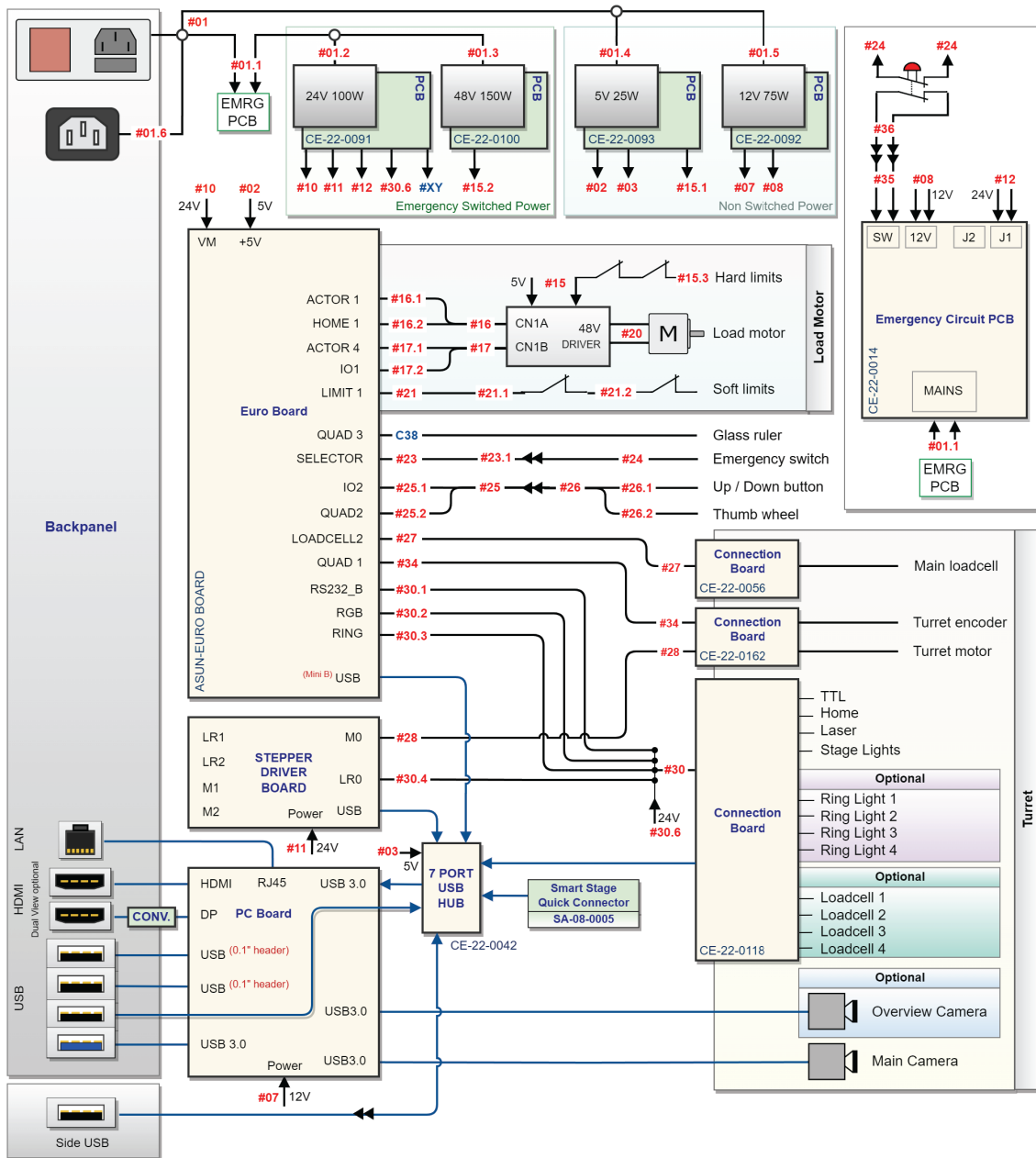

10 Manufacturer

Struers ApS
Pederstrupvej 84
DK-2750 Ballerup, Denmark
Telephone: +45 44 600 800
Fax: +45 44 600 801
www.struers.com

Responsibility of the manufacturer

The following restrictions should be observed, as violation of the restrictions may cause cancellation of Struers legal obligations.

The manufacturer assumes no responsibility for errors in the text and/or illustrations in this manual. The information in this manual is subject to change without notice. The manual may mention accessories or parts not included in the supplied version of the equipment.

The manufacturer is to be considered responsible for effects on safety, reliability, and performance of the equipment only if the equipment is used, serviced, and maintained in accordance with the instructions for use.

Declaration of Conformity

Manufacturer	Struers ApS • Pederstrupvej 84 • DK-2750 Ballerup • Denmark
Name	DuraVersa-100
Model	A, B, C
Function	Hardness tester
Type	661
Cat. no.	06616131, 06616132, 06616133, 06616233
Serial no.	



Module A, according to global approach



We declare that the product mentioned is in conformity with the following legislation, directives and standards:

2006/42/EC	EN ISO 12100:2010, EN ISO 13850:2015, EN ISO 13849-1:2015, EN ISO 13849-2:2012, EN 60204-1:2018
2011/65/EU	EN IEC 63000:2018
2012/19/EU	EN 50419:2022
2014/30/EU	EN 55011:2016/A1:2017/A11:2020, EN 61326-1:2021, EN IEC 61000-3-2:2019/A1:2021, EN IEC 61000-3-3:2013/A1:2019/A2:2021/C1:2022, EN IEC 61000-4-2:2009, EN IEC 61000-4-3:2020, EN IEC 61000-4-4:2012, EN IEC 61000-4-5:2014/A1:2018, EN IEC 61000-4-6:2023, EN IEC 61000-4-8:2010, EN IEC 61000-4-11:2020/C1:2020

Authorized to compile technical file/
Authorized signatory

Date: [Release date]

en For translations see
bg За преводи вижте
cs Překlady viz
da Se oversættelser på
de Übersetzungen finden Sie unter
el Για μεταφράσεις, ανατρέξτε στη διεύθυνση
es Para ver las traducciones consulte
et Tõlked leiate aadressilt
fi Katso käännökset osoitteesta
fr Pour les traductions, voir
hr Za prijevode idite na
hu A fordítások itt érhetők el
it Per le traduzioni consultare
ja 翻訳については、
lt Vertimai patalpinti
lv Tulkojumus skatīt
nl Voor vertalingen zie
no For oversettelser se
pl Aby znaleźć tłumaczenia, sprawdź
pt Consulte as traduções disponíveis em
ro Pentru traduceri, consultați
se För översättningar besök
sk Preklady sú dostupné na stránke
sl Za prevode si oglejte
tr Çeviriler için bkz
zh 翻译见

www.struers.com/Library